

1 GHz – 8 GHz Double Ridged Horn Antenna

1 Introduction

CISPR 16 divides the frequency range into several bands and defines specific antennas for each of these bands. For the frequency range above 1 GHz, CISPR 16 specifies using wideband horn antennas for radiated noise measurements.

Standard wideband horn antennas for EMC applications are quite costly and cover a frequency range far wider than available on typical low cost EMC pre-compliance spectrum analyzers. In order to provide an antenna optimized for pre-compliance EMC testing applications above 1 GHz, Tekbox designed the TBMA4 double ridged horn measurement antenna. With its moderate price, it is an affordable product for radiated noise EMC pre-compliance testing and generating defined field strengths.

The TBMA4 is characterized from 1 GHz to 8 GHz and has a directional pattern typical for double ridged horn antennas.

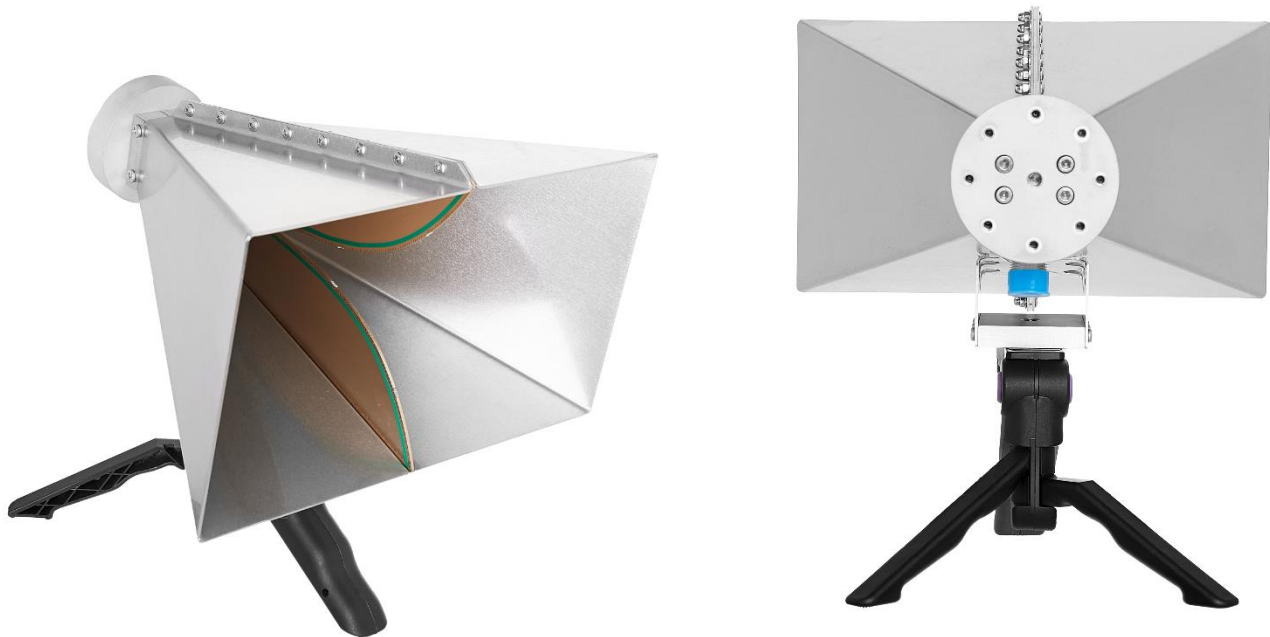

2 Product overview

The TBMA4 is a small double ridged horn antenna, with its radiating element made from edge plated PCB substrate. The housing is made from stainless steel. It is equipped with a standard female N-connector and comes together with a “pistol-grip” tripod. A standard $\frac{1}{4}$ ” thread on the bottom of the antenna makes it easy to connect it to most standard tripods. Furthermore, the antenna is equipped with an indexed mounting plate on its rear. This accessory has a 6mm threaded hole in its centre and radially positioned 4mm threaded holes in 45° steps, typical for most horn antennas.

1 GHz – 8 GHz Double Ridged Horn Antenna

3 Technical specifications

- Type: double ridged horn
- Frequency range: 1 GHz – 8 GHz
- Nominal impedance: 50 Ω
- Connector: N type female
- Maximum continuous input RF power: 100 W
- Isotropic gain: 6 ... 14 dBi
- Antenna factor: 24 ... 43 dB/m
- Front to back ratio: avg. 20 dB
- Voltage Standing Wave Ratio (VSWR): < 3:1 over the entire frequency range; < 2:1 average
- Width: 241 mm (9.49 ")
- Height: 153 mm (6.03 ")
- Depth: 214 mm (8.44 ")
- Weight: 1.4 kg (3.08 lbs)
- Tripod Adapter Thread Size: 1/4"
- Indexed rear mounting flange

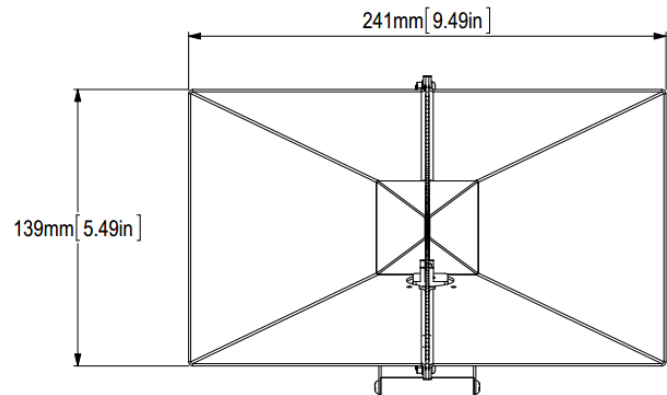
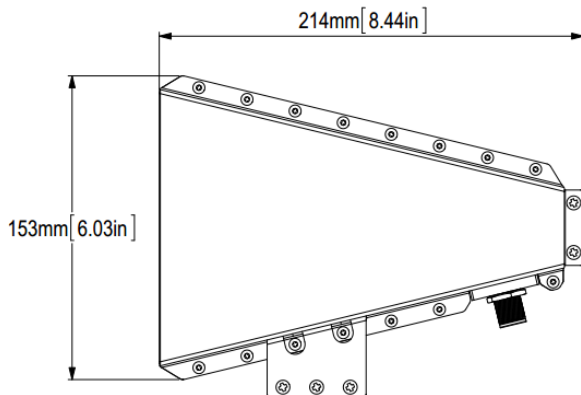

1 GHz – 8 GHz Double Ridged Horn Antenna

4 TBMA4 Antenna characterization

4.1 Gain & Antenna Factor versus frequency

Frequency	Wavelength	Gain (Isotropic)	Gain (Dipole)	Antenna Factor
MHz	m	dBi	dBd	dB/m
1000	0.300	6.17	4.02	24.13
1200	0.250	6.86	4.71	25.02
1400	0.214	7.30	5.15	25.92
1600	0.188	8.22	6.07	26.16
1800	0.167	9.85	7.70	25.56
2000	0.150	10.66	8.51	25.66
2200	0.136	7.41	5.26	29.74
2400	0.125	9.00	6.85	28.90
2600	0.115	10.98	8.83	27.62
2800	0.107	10.23	8.08	29.01
3000	0.100	9.94	7.79	29.90
3200	0.094	10.52	8.37	29.88
3400	0.088	11.92	9.77	29.01
3600	0.083	11.40	9.25	30.03
3800	0.079	11.60	9.45	30.30
4000	0.075	11.68	9.53	30.66
4200	0.071	12.41	10.26	30.35
4400	0.068	12.13	9.98	31.04
4600	0.065	11.84	9.69	31.72
4800	0.063	12.39	10.24	31.53
5000	0.060	12.54	10.39	31.74
5200	0.058	12.85	10.70	31.77
5400	0.056	14.62	12.47	30.33
5600	0.054	13.96	11.81	31.30
5800	0.052	11.50	9.35	34.07
6000	0.050	11.02	8.87	34.84
6200	0.048	10.28	8.13	35.87
6400	0.047	9.61	7.46	36.81
6600	0.045	8.95	6.80	37.74
6800	0.044	8.81	6.66	38.14
7000	0.043	7.55	5.40	39.65
7200	0.042	7.95	5.80	39.50
7400	0.041	7.50	5.35	40.18
7600	0.039	7.22	5.07	40.70
7800	0.038	7.51	5.36	40.63
8000	0.038	5.44	3.29	42.92

1 GHz – 8 GHz Double Ridged Horn Antenna

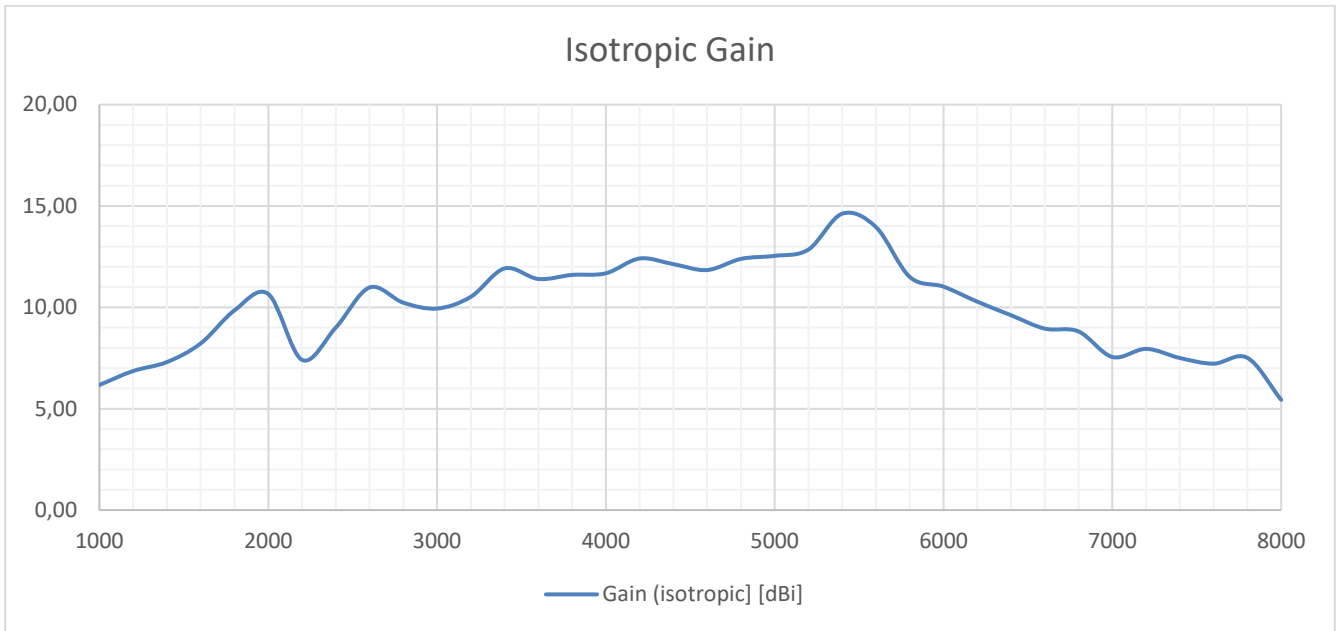

1 GHz...8 GHz, Isotropic Gain of TBMA4

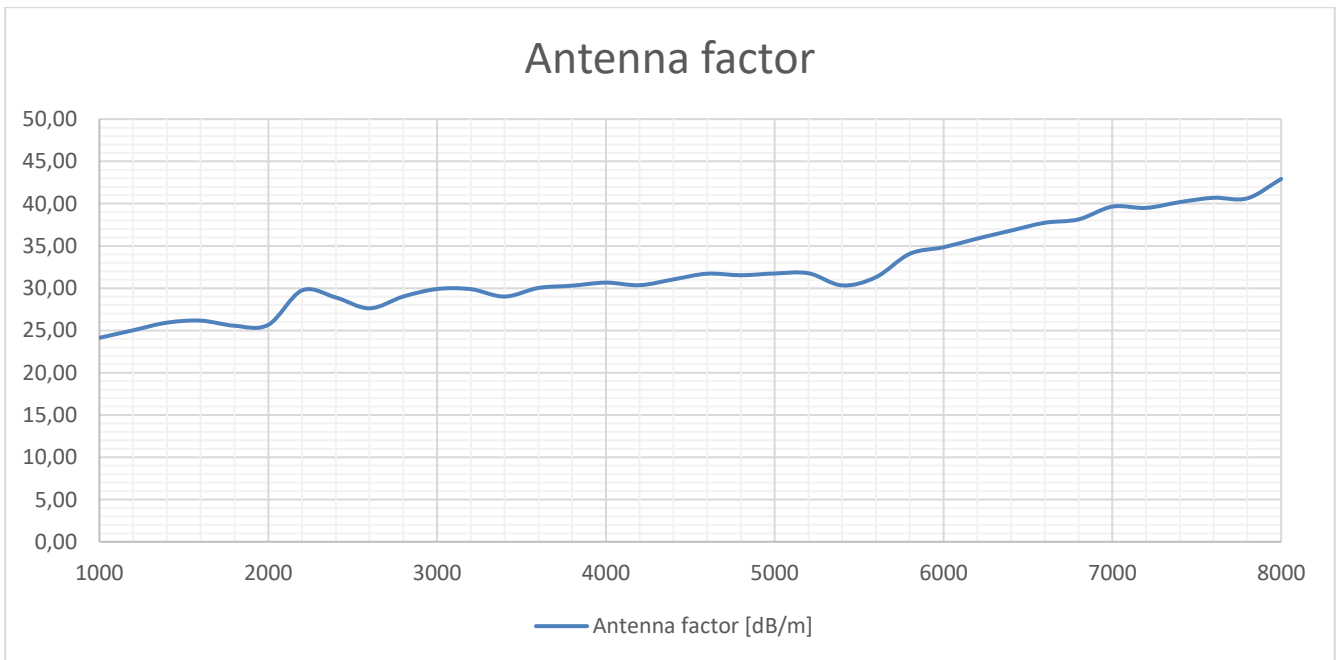

1 GHz – 8 GHz Double Ridged Horn Antenna

1 GHz...8 GHz, Antenna Factor of TBMA4

4.2 TBMA4 Return Loss / VSWR

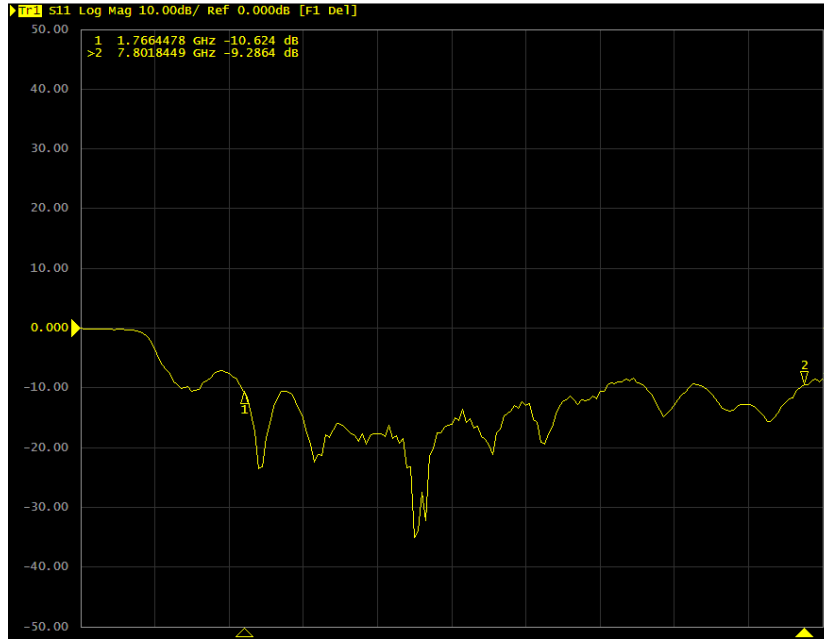

TBMA4, S11, 300 kHz...8 GHz

1 GHz – 8 GHz Double Ridged Horn Antenna

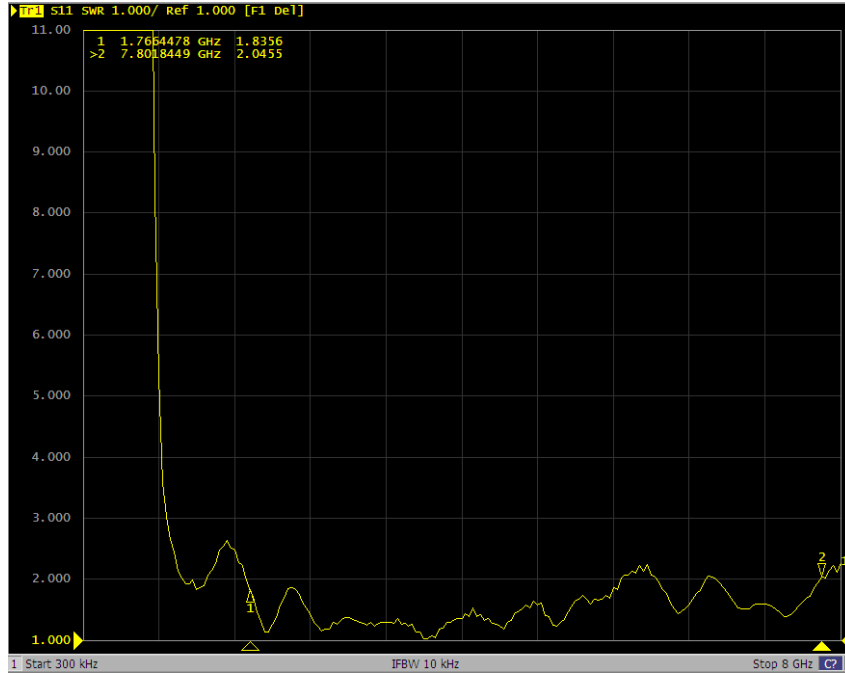

TBMA4, VSWR, 300 kHz...8GHz

4.3 Directional plots

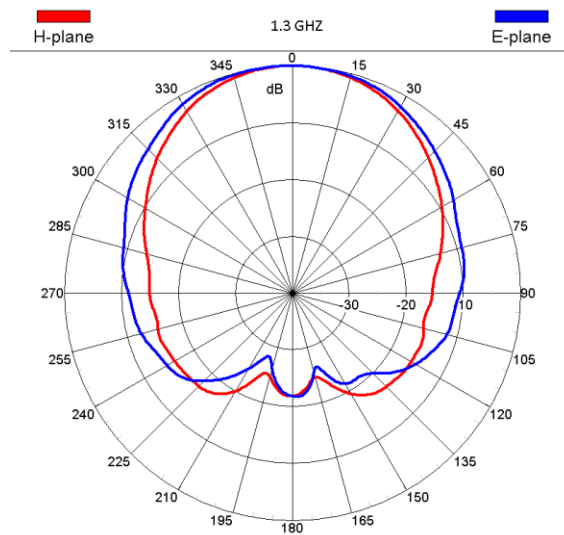
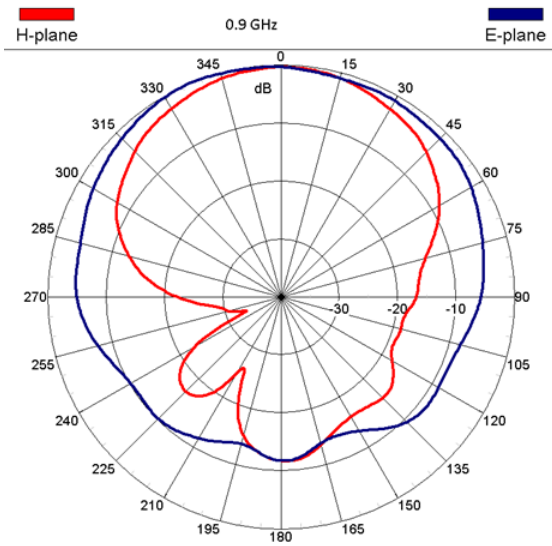

1 GHz – 8 GHz Double Ridged Horn Antenna

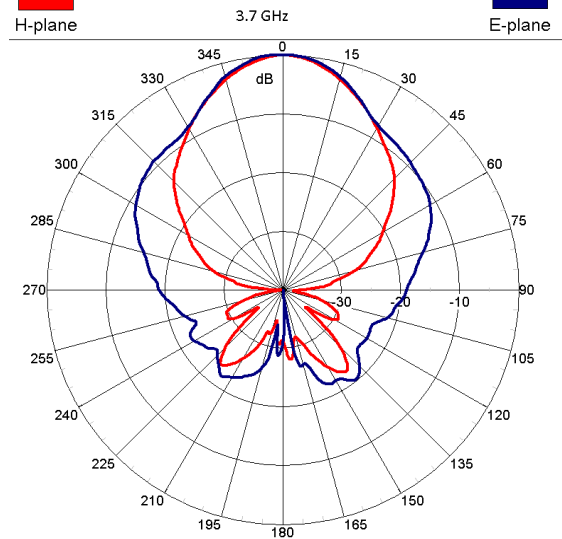
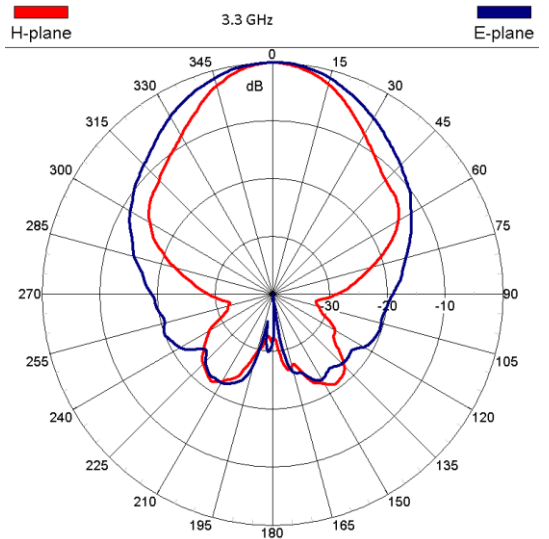
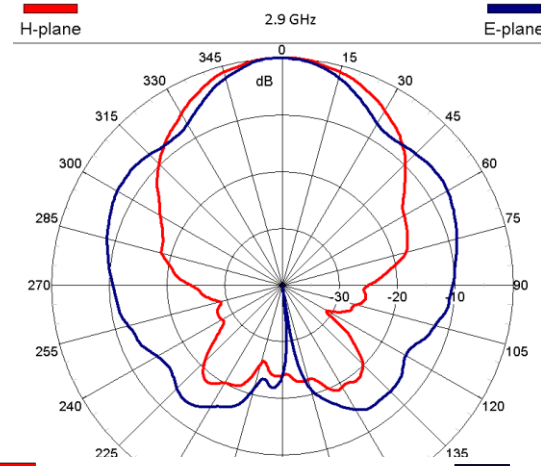
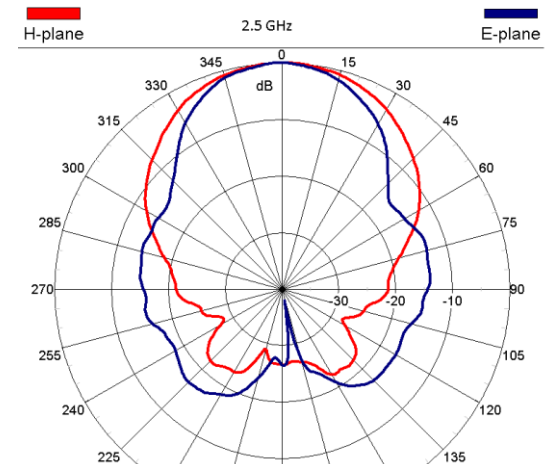
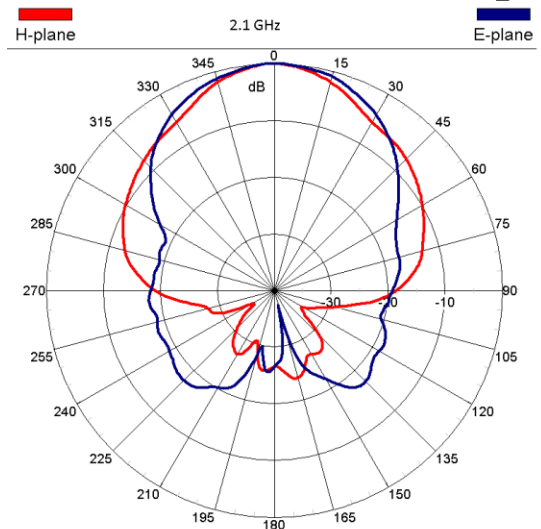
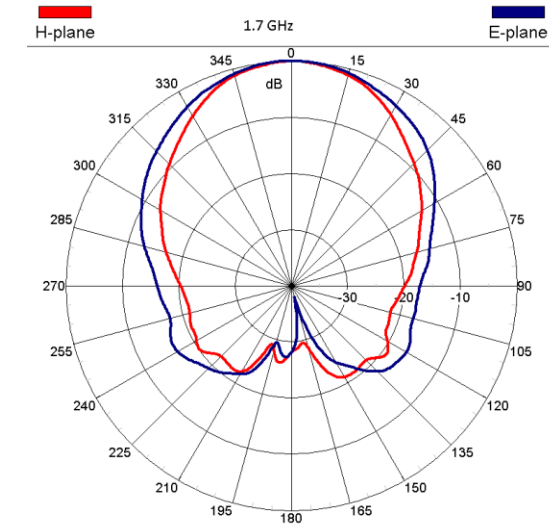

1 GHz – 8 GHz Double Ridged Horn Antenna

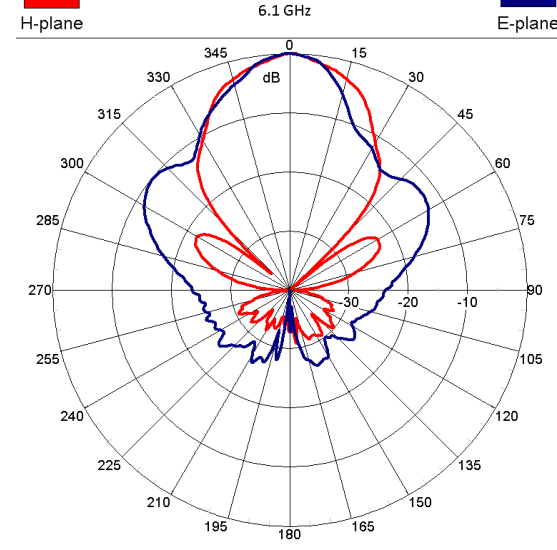
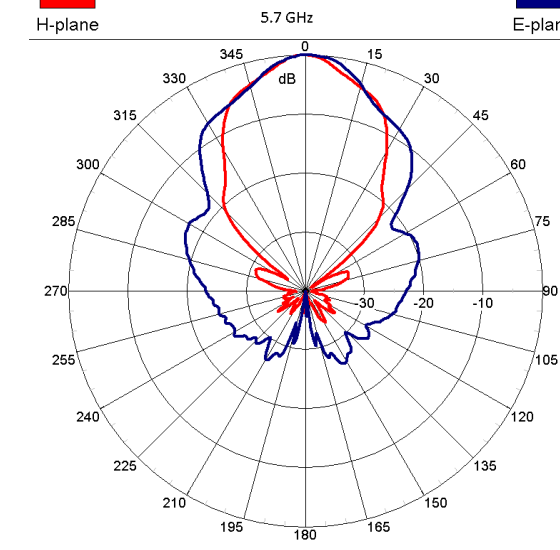
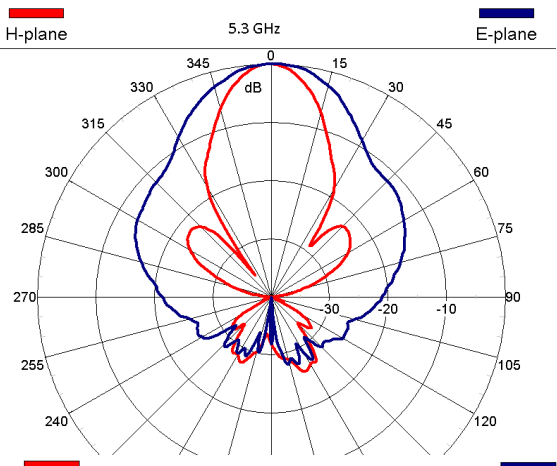
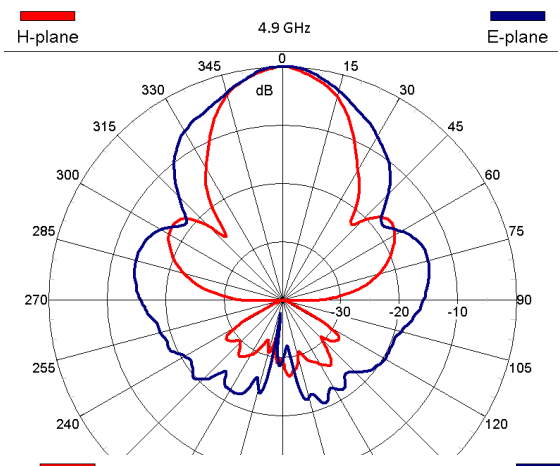
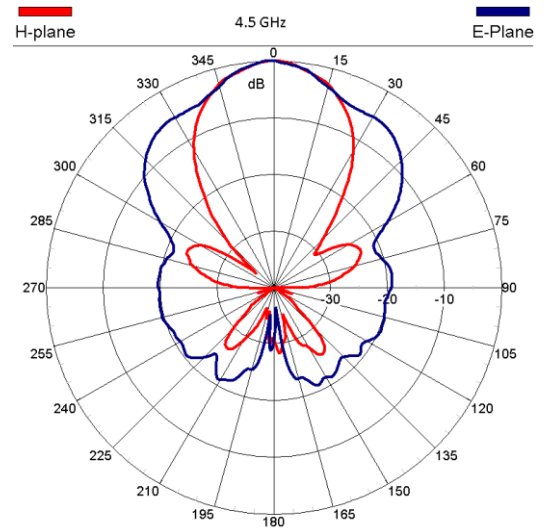
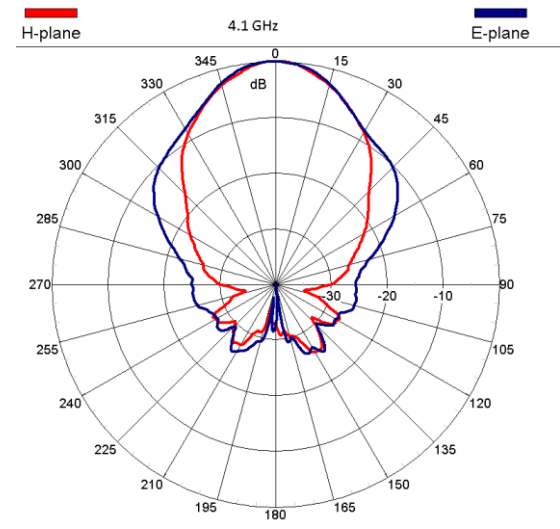

1 GHz – 8 GHz Double Ridged Horn Antenna

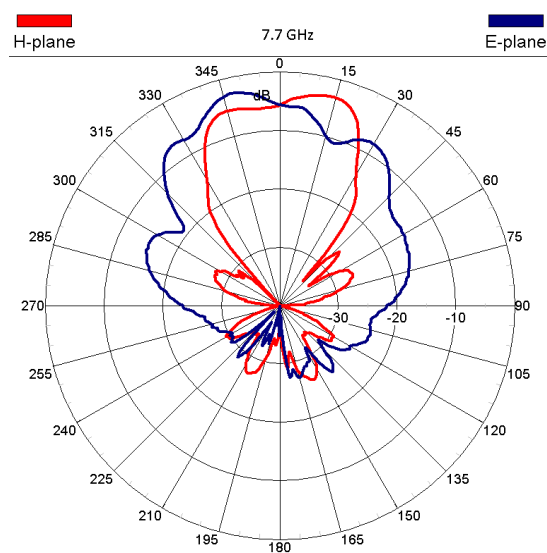
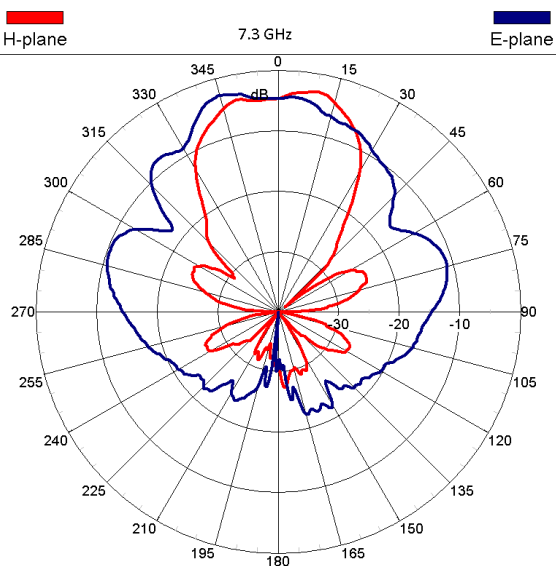
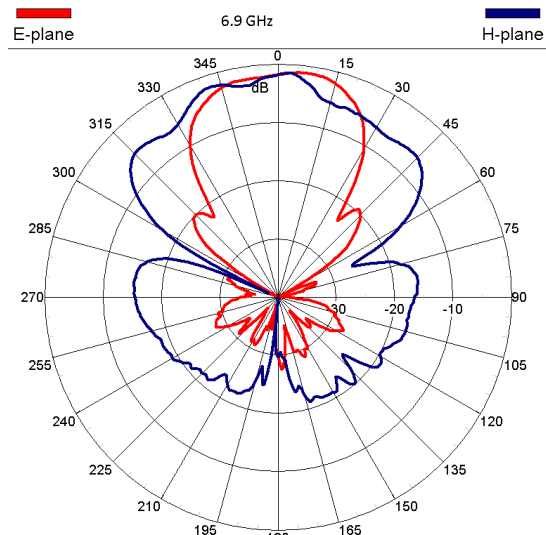
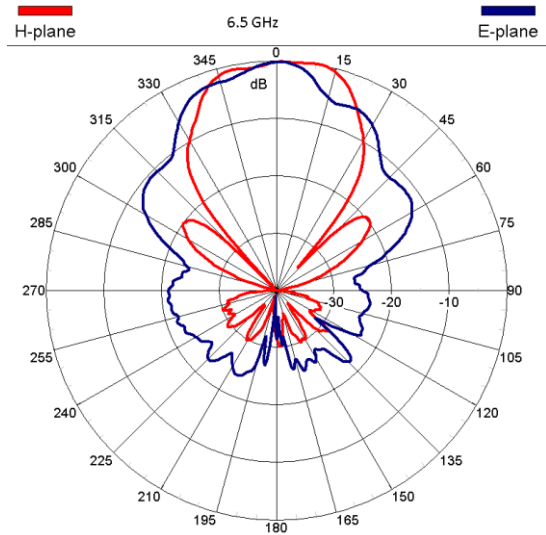

5 ..

The TBMA4 was designed, targeting radiated noise EMC pre-compliance measurements in the frequency range 1 GHz to 8 GHz. To In order to make optimum use of the TBMA4, a few details need to be considered:

The antenna factor has to be added to the measurement result in order to convert the level [dBm] into an equivalent electrical field strength [dBm]. This conversion will also add to the base noise level of the spectrum analyzer which reduces the margin between base noise and limit lines.

If there is no risk of overloading the spectrum analyzer RF-input, decrease the internal attenuation to 0 dB and turn on the pre-amplifier to optimize the dynamic range of the measurement. Use a low loss coaxial cable to connect the antenna to the spectrum analyzer. CISPR 16 specifies a resolution bandwidth of 1 MHz for frequencies above 1 GHz. Consequently, lowering the RBW cannot be utilized to reduce the base noise level. However, in cases of standards with challenging limits with respect to the base noise level of pre-compliance spectrum analyzers, the antenna could be moved closer to the DUT

1 GHz – 8 GHz Double Ridged Horn Antenna

and the limits converted accordingly. This will result in additional margin between base noise and limit levels. Since the TBMA4 is used for measurements above 1 GHz, 10m or 3m distance limits could be converted to 1m distance limits, resulting in 20dB or 10 dB additional margin to the base noise level. With 1m distance and measurement frequencies > 1GHz, the antenna is already in the far field for any frequency.

Use the table below in order to convert limits to another measurement distance:

Conversion 3 m to 1 m	add 9.5 dB to the 3m limits
Conversion 10 m to 1 m	add 20 dB to the 10m limits
Conversion 10 m to 3 m	add 10.5 dB to the 10m limits

The table above is based on following formula:

$$P_s = P_m + 20 \log \frac{D_m}{D_s} \text{ [dBm]}$$

where D_m is the actual measurement distance and D_s is the specified distance in the relevant standard.

P_m is the RF power measured in the actual measurement distance.

P_s represents the calculated equivalent RF power in the distance specified in the relevant standard.

6 Accessories



TBMA4-PAI POM adapter with standard 1/4" thread



TBMA4-PAT POM adapter for TBTP3 tripod

+ TBMA4-MR aluminum mounting rod 300mm / Φ 22mm;

7 Ordering Information

Part Number	Description
TBMA4	1 GHz – 8 GHz double ridged horn measurement antenna, mini tripod
TBMA4 - MR	Optional accessory: aluminum mounting rod 300mm / Φ 22mm for TBMA4 horn antenna
TBMA4 - PAI	Optional accessory: Φ 22mm POM adapter with standard 1/4" thread
TBMA4 - PAT	Optional accessory: Φ 22mm POM adapter for TBTP3 tripod

1 GHz – 8 GHz Double Ridged Horn Antenna

8 History

Version	Date	Author	Changes
V1.0	9.11.2020	Mayerhofer	Creation of the document
V1.1	18.3.2021	Mayerhofer	Update of chapter 2
V1.2	26.12.2023	Mayerhofer	Update of chapter 2
V1.3	12.08.2024	Mayerhofer	Update of chapter 3