

# **RIGOL**

## **User Guide**

# **DSG3000B Series RF Signal Generator**

**Aug. 2020**  
**RIGOL TECHNOLOGIES CO., LTD.**



---

# Guaranty and Declaration

## Copyright

© 2020 **RIGOL** TECHNOLOGIES CO., LTD. All Rights Reserved.

## Trademark Information

**RIGOL**® is the trademark of **RIGOL** TECHNOLOGIES CO., LTD.

## Publication Number

UGG03100-1110

## Software Version

00.01.00

Software upgrade might change or add product features. Please acquire the latest version of the manual from **RIGOL** website or contact **RIGOL** to upgrade the software.

## Notices

- **RIGOL** products are covered by P.R.C. and foreign patents, issued and pending.
- **RIGOL** reserves the right to modify or change parts of or all the specifications and pricing policies at the company's sole decision.
- Information in this publication replaces all previously released materials.
- Information in this publication is subject to change without notice.
- **RIGOL** shall not be liable for either incidental or consequential losses in connection with the furnishing, use, or performance of this manual, as well as any information contained.
- Any part of this document is forbidden to be copied, photocopied, or rearranged without prior written approval of **RIGOL**.

## Product Certification

**RIGOL** guarantees that this product conforms to the national and industrial standards in China as well as the ISO9001:2015 standard and the ISO14001:2015 standard. Other international standard conformance certifications are in progress.

## Contact Us

If you have any problem or requirement when using our products or this manual, please contact **RIGOL**.

E-mail: [service@rigol.com](mailto:service@rigol.com)

Website: [www.rigol.com](http://www.rigol.com)

# Safety Requirement

## General Safety Summary

Please review the following safety precautions carefully before putting the instrument into operation so as to avoid any personal injury or damage to the instrument and any product connected to it. To prevent potential hazards, please follow the instructions specified in this manual to use the instrument properly.

### **Use Proper Power Cord.**

Only the exclusive power cord designed for the instrument and authorized for use within the local country could be used.

### **Ground the Instrument.**

The instrument is grounded through the Protective Earth lead of the power cord. To avoid electric shock, connect the earth terminal of the power cord to the Protective Earth terminal before connecting any input or output terminals.

### **Connect the Probe Correctly.**

If a probe is used, the probe ground lead must be connected to earth ground. Do not connect the ground lead to high voltage. Improper way of connection could result in dangerous voltages being present on the connectors, controls or other surfaces of the oscilloscope and probes, which will cause potential hazards for operators.

### **Observe All Terminal Ratings.**

To avoid fire or shock hazard, observe all ratings and markers on the instrument and check your manual for more information about ratings before connecting the instrument.

### **Use Proper Overvoltage Protection.**

Ensure that no overvoltage (such as that caused by a bolt of lightning) can reach the product. Otherwise, the operator might be exposed to the danger of an electric shock.

### **Do Not Operate Without Covers.**

Do not operate the instrument with covers or panels removed.

### **Do Not Insert Objects into the Air Outlet.**

Do not insert objects into the air outlet, as doing so may cause damage to the instrument.

### **Use Proper Fuse.**

Please use the specified fuses.

**Avoid Circuit or Wire Exposure.**

Do not touch exposed junctions and components when the unit is powered on.

**Do Not Operate with Suspected Failures.**

If you suspect that any damage may occur to the instrument, have it inspected by **RIGOL** authorized personnel before further operations. Any maintenance, adjustment or replacement especially to circuits or accessories must be performed by **RIGOL** authorized personnel.

**Provide Adequate Ventilation.**

Inadequate ventilation may cause an increase of temperature in the instrument, which would cause damage to the instrument. So please keep the instrument well ventilated and inspect the air outlet and the fan regularly.

**Do Not Operate in Wet Conditions.**

To avoid short circuit inside the instrument or electric shock, never operate the instrument in a humid environment.

**Do Not Operate in an Explosive Atmosphere.**

To avoid personal injuries or damage to the instrument, never operate the instrument in an explosive atmosphere.

**Keep Instrument Surfaces Clean and Dry.**

To avoid dust or moisture from affecting the performance of the instrument, keep the surfaces of the instrument clean and dry.

**Prevent Electrostatic Impact.**

Operate the instrument in an electrostatic discharge protective environment to avoid damage induced by static discharges. Always ground both the internal and external conductors of cables to release static before making connections.

**Use the Battery Properly.**

Do not expose the battery (if available) to high temperature or fire. Keep it out of the reach of children. Improper change of a battery (lithium battery) may cause an explosion. Use the **RIGOL** specified battery only.

**Do Not Overload the Output.**

In order to avoid damage to the instrument, the reverse DC voltage on the RF output connector cannot exceed 50 V; the reverse power must be less than +40 dBm (10 W) in the frequency range from 1 MHz to 12 GHz.

**Handle with Caution.**

Please handle with care during transportation to avoid damage to keys, knobs, interfaces, and other parts on the panels.

## Safety Notices and Symbols

### Safety Notices in this Manual:



#### **WARNING**

Indicates a potentially hazardous situation or practice which, if not avoided, will result in serious injury or death.



#### **CAUTION**

Indicates a potentially hazardous situation or practice which, if not avoided, could result in damage to the product or loss of important data.

### Safety Terms on the Product:

**DANGER** It calls attention to an operation, if not correctly performed, could result in injury or hazard immediately.

**WARNING** It calls attention to an operation, if not correctly performed, could result in potential injury or hazard.

**CAUTION** It calls attention to an operation, if not correctly performed, could result in damage to the product or other devices connected to the product.

### Safety Symbols on the Product:



Hazardous  
Voltage



Safety  
Warning



Protective  
Earth  
Terminal



Chassis  
Ground



Test  
Ground

## Ventilation Requirement

The instrument uses a fan to force cooling. Please make sure that the air intake and exhaust areas are free from obstructions and have free air. When using the instrument in a bench-top or rack setting, provide at least 10 cm clearance beside, above and behind the instrument for adequate ventilation.



#### **WARNING**

Inadequate ventilation may cause an increase of temperature in the instrument, which would cause damage to the instrument. So please keep the instrument well ventilated and inspect the air outlet and the fan regularly.

## Working Environment

### Temperature

Operating: 0°C to +50°C

Non-operating: -20°C to +70°C

### Humidity

Operating:

0°C to 30°C: ≤95%RH (without condensation)

30°C to 40°C: ≤75%RH (without condensation)

40°C to 50°C: ≤45%RH (without condensation)



#### **WARNING**

To avoid short circuit inside the instrument or electric shock, never operate the instrument in a humid environment.

---

### Altitude

Operating: below 3 km

### Installation (Overvoltage) Category

This product is powered by mains conforming to installation (overvoltage) category II.



#### **WARNING**

Ensure that no overvoltage (such as that caused by a bolt of lightning) can reach the product. Otherwise, the operator might be exposed to the danger of an electric shock.

---

### Installation (Overvoltage) Category Definitions

Installation (overvoltage) category I refers to signal level which is applicable to equipment measurement terminals connected to the source circuit. Among these terminals, precautions are done to limit the transient voltage to a low level.

Installation (overvoltage) category II refers to the local power distribution level which is applicable to equipment connected to the AC line (AC power).

### Pollution Degree

Pollution Degree 2

### Pollution Degree Definition

Pollution Degree 1: No pollution or only dry, nonconductive pollution occurs. The pollution has no effect. For example, a clean room or air-conditioned office environment.

Pollution Degree 2: Normally only nonconductive pollution occurs. Temporary

conductivity caused by condensation is to be expected. For example, indoor environment.

Pollution Degree 3: Conductive pollution or dry nonconductive pollution that becomes conductive due to condensation occurs. To be found in industrial environment or construction sites (harsh environments). For example, sheltered outdoor environment.

Pollution Degree 4: The pollution generates persistent conductivity caused by conductive dust, rain, or snow.  
For example, outdoor areas.

**Safety Class**

Class 1 – Grounded Product



## Care and Cleaning

### Care

Do not store or leave the instrument where it may be exposed to direct sunlight for long periods of time.

### Cleaning

Clean the instrument regularly according to its operating conditions.

1. Disconnect the instrument from all power sources.
2. Clean the external surfaces of the instrument with a soft cloth dampened with mild detergent or water. Avoid having any water or other objects into the chassis via the heat dissipation hole. When cleaning the LCD, take care to avoid scarifying it.



---

**CAUTION**

To avoid damage to the instrument, do not expose it to caustic liquids.

---



---

**WARNING**

To avoid short-circuit resulting from moisture or personal injuries, ensure that the instrument is completely dry before connecting it to the power supply.

---

## Environmental Considerations

The following symbol indicates that this product complies with the WEEE Directive 2002/96/EC.



### Product End-of-Life Handling

The equipment may contain substances that could be harmful to the environment or human health. To avoid the release of such substances into the environment and avoid harm to human health, we recommend you to recycle this product appropriately to ensure that most materials are reused or recycled properly. Please contact your local authorities for disposal or recycling information.

You can click on the following link <https://int.rigol.com/services/declaration.html> to download the latest version of the RoHS&WEEE certification file.

## DSG3000B Series Overview

The DSG3000B series is a high-performance RF signal generator. It provides comprehensive modulation solutions: AM/FM/ $\phi$ M analog modulation; pulse modulation with user-defined pulse train; and I/Q modulation. All the modulations support internal and external modulation sources. In addition, to meet the demands of production environments, the DSG3000B series has undergone a strict verification through the experiments in its design and production stages to ensure its high stability and reliability. The DSG3000B series also features a clear user interface, compact size and light weight. It is easy to operate and can output stable, precise and pure signals. It is an ideal tool in various fields such as communication, computers, instrumentation, R&D, education, production and maintenance.

### Main Features:

- Highest frequency: 6.5 GHz/13.6 GHz
- Amplitude accuracy: <0.5 dB (typical)
- Output amplitude range: -130 dBm to +27 dBm (settable)
- High signal purity, phase noise: <-116 dBc/Hz@20 kHz (typical)
- Standard 0.5ppm internal clock; optional 5ppb high stable clock
- Standard AM/FM/ $\phi$ M analog modulation
- Support pulse modulation; on/off ratio up to 70 dB; user-defined pulse train generator
- I/Q modulation and I/Q baseband output
- All modulation schemes support internal and external modulation modes
- Standard 2U height design to save rack space. Rack mount kit is available
- Support USB/LAN/GPIB remote control interfaces; SCPI command set
- Wear-free electronic attenuator design

---

# Document Overview

## Main contents in this manual

### **Chapter 1 Quick Start**

This chapter introduces the front panel, rear panel and user interface of the RF signal generator as well as the precautions when using the instrument for the first time.

### **Chapter 2 Front Panel Operations**

This chapter describes the front panel function keys of the RF signal generator and introduces the menu functions under each key in details.

### **Chapter 3 Remote Control**

This chapter introduces the remote control method of RF signal generator.

### **Chapter 4 Application Examples**

This chapter describes intuitively RF signal generator with operation examples.

### **Chapter 5 Troubleshooting**

This chapter lists commonly encountered failures that may appear during the use of the RF signal generator and their solutions.

### **Chapter 6 Appendix**

This chapter provides the information about the options and accessories, as well as other points for attention.

## Format Conventions in this Manual

### 1. Key

The key on the front panel is denoted by the format of "Key Name (Bold) + Text Box" in the manual. For example, **FREQ** denotes the **FREQ** key.

### 2. Menu

The menu items are denoted by the format of "Menu Word (Bold) + Character Shading". For example, **Frequency** denotes the "Frequency" menu item under **FREQ**.

### 3. Connector

The connectors on the front or rear panel are usually denoted by the format of "Connector Name (Bold) + Square Brackets (Bold)". For example, **[RF OUTPUT 50Ω]**.

### 4. Operation Procedures

The next step of the operation is denoted by an arrow "→" in the manual. For example, **FREQ** → **Frequency** denotes pressing **FREQ** on the front panel first and then pressing **Frequency**.

## Content Conventions in this Manual

The DSG3000B series RF signal generator includes DSG3065B, DSG3065B-IQ, DSG3136B, and DSG3136B-IQ. This manual takes DSG3136B-IQ as an example to illustrate the functions and operation methods of DSG3000B series.

Model	RF Frequency Range	IQ Frequency Range
DSG3065B	9 kHz to 6.5 GHz	N/A
DSG3065B-IQ	9 kHz to 6.5 GHz	50 MHz to 6.5 GHz
DSG3136B	9 kHz to 13.6 GHz	N/A
DSG3136B-IQ	9 kHz to 13.6 GHz	50 MHz to 6.5 GHz

## Manuals of this Product

Quick Guide, User Guide, Programming Guide, Data sheet, etc. For the latest version of this manual, download it from the official website of **RIGOL** ([www.rigol.com](http://www.rigol.com)).

# Contents

<b>Guaranty and Declaration .....</b>	<b>I</b>
<b>Safety Requirement .....</b>	<b>II</b>
General Safety Summary .....	II
Safety Notices and Symbols.....	IV
Care and Cleaning .....	VII
Environmental Considerations.....	VII
<b>DSG3000B Series Overview .....</b>	<b>VIII</b>
<b>Document Overview.....</b>	<b>IX</b>
<b>Chapter 1 Quick Start .....</b>	<b>1-1</b>
General Inspection .....	1-2
Appearance and Dimensions.....	1-3
Front Panel Overview.....	1-5
Rear Panel Overview.....	1-12
To Use DSG3000B for the First Time.....	1-16
To Connect the Power Supply.....	1-16
Turn-on Checkout .....	1-16
To Set the System Language.....	1-17
To Replace the Fuse .....	1-18
User Interface.....	1-19
Normal Display Mode .....	1-19
Parameter Zoom-in Mode.....	1-22
To Use the Built-in Help System .....	1-23
<b>Chapter 2 Front Panel Operations .....</b>	<b>2-1</b>
To Set the Frequency Parameters.....	2-2
Frequency .....	2-2
Frequency Offset .....	2-2
Phase Offset.....	2-3
To Set the Amplitude Parameters .....	2-4
Amplitude .....	2-4
Amplitude Limit .....	2-4
Amplitude Offset.....	2-5
Flatness Calibration .....	2-6
Amplitude Unit.....	2-6
Sweep.....	2-7
Sweep Manner.....	2-7
Sweep Direction.....	2-7
Sweep Type.....	2-8
Sweep Mode.....	2-11
Single Sweep.....	2-11
Reset Sweep .....	2-11
Trigger Mode.....	2-11

Modulation .....	2-15
Amplitude Modulation (AM) .....	2-15
Frequency Modulation (FM) .....	2-18
Phase Modulation ( $\phi$ M).....	2-21
Pulse Modulation .....	2-24
I/Q Modulation .....	2-30
LF Output.....	2-36
To Enable the LF Output.....	2-36
To Set the LF Parameters .....	2-36
Store and Recall.....	2-38
File Type.....	2-38
Save.....	2-39
Recall .....	2-43
Rename.....	2-43
Delete .....	2-43
Copy .....	2-43
To Create a Directory .....	2-44
Filename Prefix.....	2-44
Disk Management.....	2-44
System Update.....	2-44
To Set the System Parameters .....	2-46
Language .....	2-46
Reset.....	2-46
I/O Configuration.....	2-47
Display Setting .....	2-49
Power Status.....	2-49
Information.....	2-50
License.....	2-50
Self-test.....	2-51
Sanitation .....	2-52
<b>Chapter 3 Remote Control .....</b>	<b>3-1</b>
Remote Control Overview .....	3-2
Control Via USB .....	3-3
Control Via LAN.....	3-5
<b>Chapter 4 Application Examples .....</b>	<b>4-1</b>
To Output RF Signal .....	4-2
To Output RF Sweep Signal .....	4-4
To Output RF Modulated Signal .....	4-6
<b>Chapter 5 Troubleshooting .....</b>	<b>5-1</b>
<b>Chapter 6 Appendix .....</b>	<b>6-1</b>
Appendix A: DSG3000B Accessories and Options.....	6-1
Appendix B: Warranty.....	6-2
<b>Index.....</b>	<b>1</b>

# Chapter 1 Quick Start

This chapter guides users to quickly get familiar with the appearance, dimensions, front panel, rear panel, and the user interface of DSG3000B series RF signal generator.

The contents of this chapter are as follows:

- General Inspection
- Appearance and Dimensions
- Front Panel Overview
- Rear Panel Overview
- To Use DSG3000B for the First Time
- To Replace the Fuse
- User Interface
- To Use the Built-in Help System

## General Inspection

### 1. Inspect the packaging

If the packaging has been damaged, do not dispose the damaged packaging or cushioning materials until the shipment has been checked for completeness and has passed both electrical and mechanical tests.

The consigner or carrier shall be liable for the damage to the instrument resulting from shipment. **RIGOL** would not be responsible for free maintenance/rework or replacement of the instrument.

### 2. Inspect the instrument

In case of any mechanical damage, missing parts, or failure in passing the electrical and mechanical tests, contact your **RIGOL** sales representative.

### 3. Check the accessories

Please check the accessories according to the packing lists. If the accessories are damaged or incomplete, please contact your **RIGOL** sales representative.



## Appearance and Dimensions

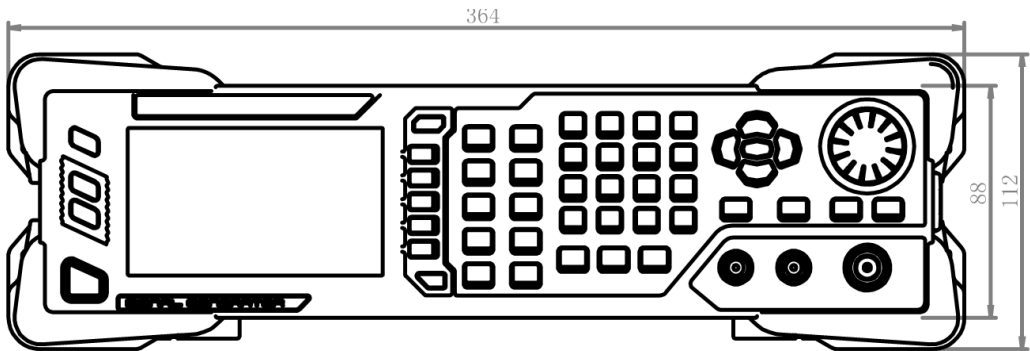

Figure 1-1 Front View (unit: mm)

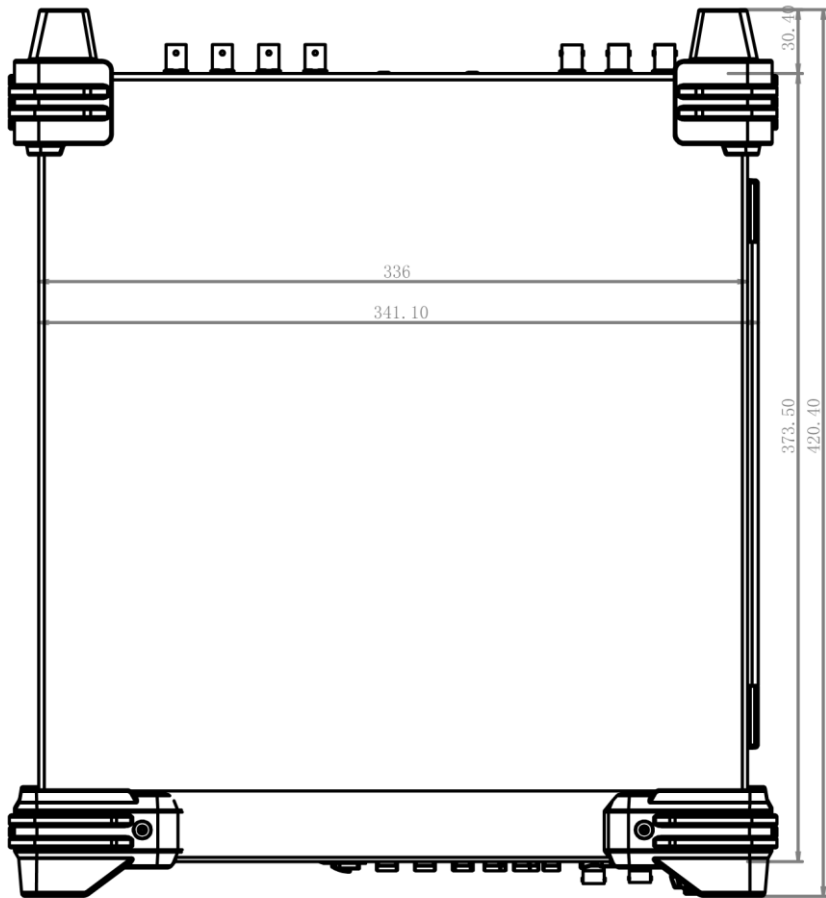

Figure 1-2 Top View (unit: mm)

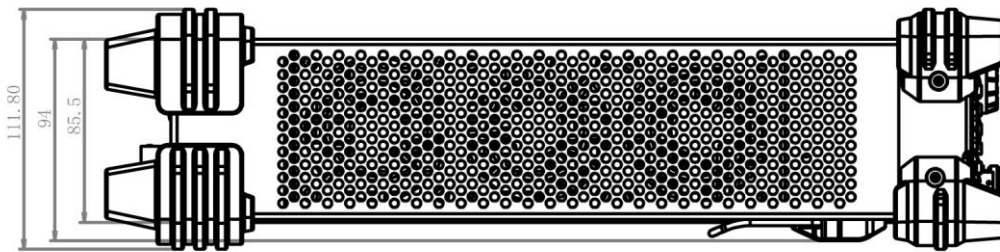

Figure 1-3 Side View (unit: mm)

## Front Panel Overview

The front panel of DSG3000B series RF signal generator is as shown in the figure below. Click the number in the figure to view the corresponding introduction.

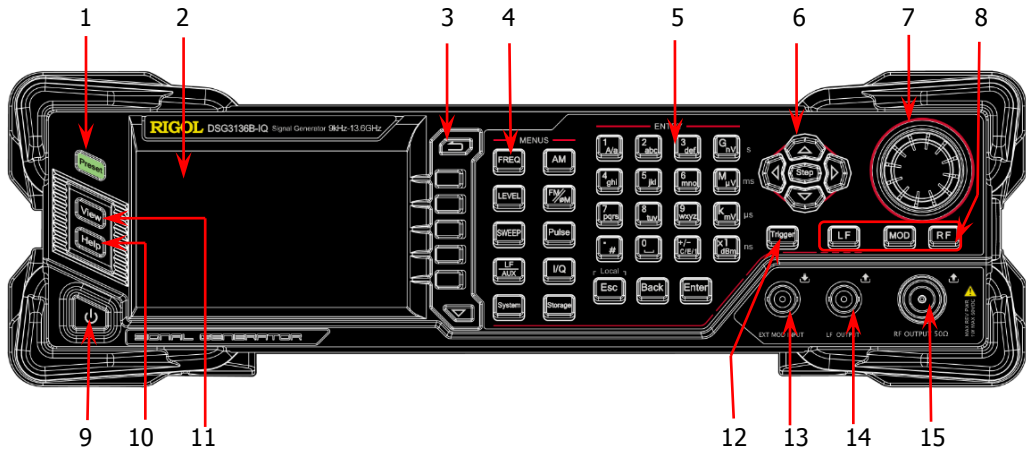

Figure 1-4 Front Panel

### 1. Restore to Preset Key



Restore the instrument to the preset state (factory state or user-stored state). For detailed information, refer to "Reset".

### 2. LCD Display

4.3-inch TFT high-resolution (480×272) color LCD display. The current settings and state of the instrument can be clearly displayed. For detailed information, refer to "User Interface".

### 3. Menu Control Keys



Quit the current menu and return to the previous menu.



Menu softkey. Corresponds to the menu label at the left of the softkey on the display. Press the softkey to activate the corresponding menu.



Menu page up/down key.

#### 4. Function Keys



Set the frequency, frequency offset and phase offset of the RF output signal. For details, refer to "**To Set the Frequency Parameters**".



Set the amplitude of the RF output signal and provide the flatness calibration function. For details, refer to "**To Set the Amplitude Parameters**".



Set the sweep type, sweep manner and sweep mode. For details, refer to "**Sweep**".



Set the parameters relating to amplitude modulation (AM). For details, refer to "**Amplitude Modulation (AM)**".



Set the parameters relating to frequency modulation (FM) and phase modulation ( $\Phi M$ ). For details, refer to "**Frequency Modulation (FM)**" and "**Phase Modulation ( $\Phi M$ )**".



Set the parameters relating to pulse modulation and pulse generator. For details, refer to "**Pulse Modulation**".



Set the parameters relating to I/Q modulation and I/Q modulation source.



Set the parameters relating to LF output.



Store and recall state files and other types of files. For details, refer to "**Store and Recall**".



Set the system-related parameters. For details, refer to "**To Set the System Parameters**".

## 5. Numeric Keyboard

The numeric keyboard supports Chinese characters, English uppercase /lowercase characters, numbers and commonly used symbols (include the decimal point, #, space and positive/negative sign+/-). It is mainly used to edit the file or folder name or set parameters.

The multiplexing key of number and letter is used to directly input the desired number or letter.



Used to switch among Chinese, English and number input modes.

When setting parameters, the input mode is fixed at number and this key is used to input the sign ("+" or "-") of the value.



In number input mode, press this key to input 1.

In English input mode, press this key to switch between uppercase and lowercase letter input.



The multiplexing key of 0 and space:

In number input mode, press this key to input 0.

In Chinese or English input mode, press this key to input a space.



In number input mode, press this key to insert a decimal point at the current cursor.

In English input mode, press this key to input "#".

In Chinese input mode, this key is invalid.

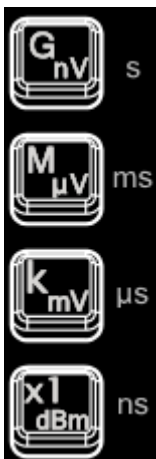

Used to set the unit of the parameter.

When setting a parameter, after using the numeric keyboard to input the numbers, press one of these keys to select the corresponding unit. The unit selected is related to the type of the parameter to be set.

Parameter	GnV	MμV	KmV	X1dBm
Frequency	GHz	MHz	kHz	Hz
Amplitude	nV	μV	mV	dBm
Period	s	ms	μs	ns



When setting parameters, use this key to clear the number in the editing window and exit the parameter input state.

When editing filenames, use this key to clear the characters in the input bar.

During the keyboard test, use this key to exit the current test state.

When the instrument is in remote mode, use this key to return to local mode.



When setting parameters, use this key to delete the number at the left of the cursor.

When editing filenames, use this key to delete the character at the left of the cursor.

For the storage function, it is used to collapse the directory currently selected.



When setting parameters, use this key to finish the parameter input and add the default unit for the parameter.

When editing filenames, use this key to input the character currently selected by the cursor.

For the storage function, it is used to expand the directory currently selected.

## 6. Arrow Keys/Step Key



When setting the parameters, **Step** is used to set the step of the parameter currently selected.

The left/right arrow keys are used to enter the parameter editing state and move the cursor to the specified digit.

The up/down arrow keys are used to modify the value at the cursor or modify the parameter value at the current step.

For the storage function, the left/right arrow keys are used to collapse or expand the directory currently selected.

The up/down arrow keys are used to select the current directory or file.

When editing filenames, they are used to select the desired character.

## 7. Knob



When setting parameters, the knob is used to modify the value at the cursor or modify the parameter value at the current step.

When editing filenames, it is used to select the desired character.

For the storage function, it is used to select the current directory or file.

## 8. Output Control Keys



Used to turn on or off the LF output.

- Press this key, the backlight lights on and the LF label is displayed in the status bar in the user interface. The LF output is turned on. At this point, the **[LF OUTPUT]** connector outputs the LF signal according to the current configuration.
- Press this key again, the backlight goes out and the LF output is turned off.



Used to turn on or off the RF output.

- Press this key, the backlight lights on and the RF label is displayed in the status bar in the user interface. The RF output is turned on. At this point, the **[RF OUTPUT 50Ω]** connector outputs RF signal or RF sweep signal according to the current configuration.
- Press this key again, the backlight goes out and the RF output is turned off.



Used to turn on or off the RF modulation output.

- Press this key, the backlight lights on and the MOD label is displayed in the status bar in the user interface. The RF modulation output is turned on. At this point, the **[RF OUTPUT 50Ω]** connector outputs modulated RF signal according to the current configuration (the backlight of **[RF]** must light on).
- Press this key again, the backlight goes out and the RF modulation output is turned off.

## 9. Power Key



Turn on or off the signal generator. When this key is turned off, the signal generator is in standby state, indicated by a pulsing LED. In addition, this key has a delayed switching function. The instrument can be turned on or off only when pressing this key and holding it down for a certain time. With this feature, you can avoid turning off the instrument because of accidentally touching the key.

Press **System** → **Power Status** to select "Open" or "Default". When "Default" is selected, after the instrument is powered on, you need to press this key to start the instrument. When "Open" is selected, the instrument will start automatically after it is powered on.

## 10. Built-in Help System



To get the help information of any front panel key or menu softkey, press this key and then press the desired key.

## 11. View Switch Key



It is used to switch the interface display mode to normal mode or parameter zoom-in mode. For details, please refer to "**User Interface**".

## 12. Trigger Control Key



When the trigger type of **SWEEP** is "Key", press this key once to trigger a sweep.

When the trigger mode of **Pulse** is "Key", press this key once to enable a pulse modulation.

## 13. External Modulation Input Connector



When the modulation source of AM, FM and  $\phi$ M is external, this connector is used to input the external modulating signal.



#### 14. LF Output Connector



When the backlight of **LF** lights on, this connector is used to output LF signal.

#### 15. RF Output Connector



When the backlight of **RF** lights on, this connector is used to output RF signal and RF sweep signal.  
When the backlights of **RF** and **MOD** light on, this connector is used to output RF modulated signal.



---

#### **CAUTION**

To avoid damage to the instrument, the reverse DC voltage on the RF output connector cannot exceed 50 V, and the reverse power must be less than 1 W.

---

# Rear Panel Overview

The rear panel of DSG3000B series RF signal generator is as shown in the figure below. Click the number in the figure to view the corresponding introduction.

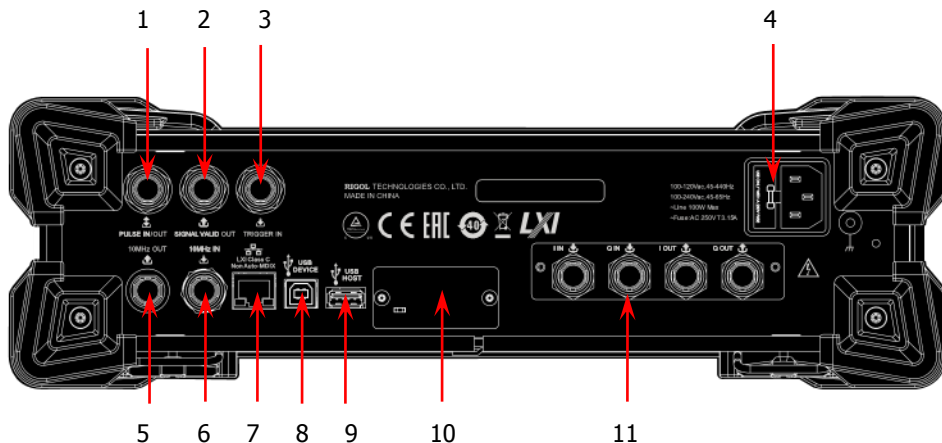
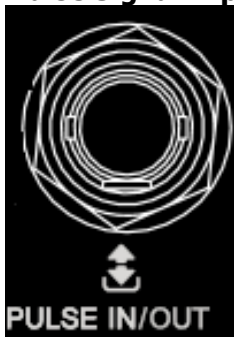

Figure 1-5 Rear Panel

## 1. Pulse Signal Input/Output Connector



The function of this connector is determined by the current working mode of the pulse modulation.

### PULSE IN:

When the modulation source of **Pulse** is external, this connector is used to input the external pulse signal.

### PULSE OUT:

When the modulation source of **Pulse** is internal and the switch of pulse output is "on", this connector is used to output the pulse signal of the internal generator. This output signal is related to the choice of pulse mode which can be set to "Single" or "Train".

## 2. Signal Valid Output Connector



When the RF output frequency or amplitude is modified, after a certain response and processing time, the internal circuit of the instrument outputs RF signal with specified frequency and amplitude via the RF output connector on the front panel. During this process, the **[SIGNAL VALID]** connector outputs a pulse sync signal, indicating that the RF output signal is valid.

- High Level (+3.3 V): indicates that the RF signal is in configuration;
- Low Level (0 V): indicates that the RF signal is stable (namely, the signal is valid).

### 3. External Trigger Input Connector



When the trigger type of **SWEEP** is "Ext", this connector is used to input the external trigger signal. You can set the polarity of trigger signal by pressing **Trig Slope** to select "Pos" or "Neg". When the trigger mode of I/Q modulation baseband output is "Ext", this connector is used to input the external trigger signal. When the pulse modulation source is "Int" and the trigger mode is "Ext Trig", it is used to input the external trigger signal. When the pulse modulation source is "Int" and the trigger mode is "Ext Gate", it is used to input the external gated signal.

### 4. Power Input Connector, Fuse and Switch

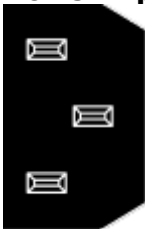

Power input connector.

This signal generator supports 100-240 V, 45-440 Hz; 100-240 Vac, 45-65 Hz. The power consumption of the instrument cannot exceed 100 W. When the signal generator is connected to AC power supply via this connector, the instrument selects the correct voltage range automatically and users do not need to select the voltage range manually.



Fuse.

The fuse specification of this signal generator is AC 250 V, T3.15 A.

If the fuse needs to be replaced, please refer to "**To Replace the Fuse**".

### 5. Reference Signal Output Connector

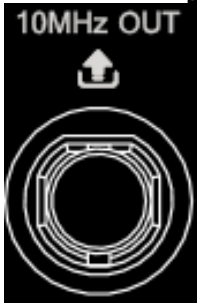

It is used to output the internal 10 MHz reference clock signal used to synchronize the generator with other instruments. For more information about the output clock signal specification of this connector, please refer to *DSG3000B Data Sheet*.

### 6. Reference Signal Input Connector



It is used to input the external 10 MHz reference clock signal which is used to synchronize the generator with other instruments. For more information about the external clock signal specification of this connector, please refer to *DSG3000B Data Sheet*.

### 7. LAN

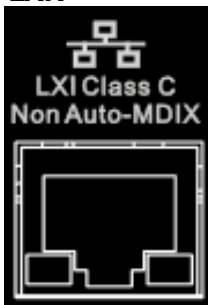

The instrument complies with LXI Device Specification 2011 standard, and supports WebServer, Socket and other remote control modes. This interface is used to connect the PC or network for remote instrument control.

### 8. USB Device



The instrument complies with USBTMC class protocol. This interface is used to connect to a PC for remote instrument control.

## 9. USB Host



This input is used to connect the USB storage device to update the system, store system states and sweep lists.

## 10. OCXO (option OCXO-B08)



OCXO is an oven-controlled crystal oscillator. It is a frequency reference source with higher temperature stability.

**NOTE:** Forty minutes of warm-up is required for the OCXO to reach its rated frequency.

For ordering information of this option, please refer to *DSG3000B Data Sheet*.

## 11. I/Q Modulating Signal In/Out Connectors



When I/Q modulation type is "external", it is used to input the I (In-Phase) baseband signal of I/Q modulation.



When I/Q modulation type is "external", it is used to input the Q (Quadrature Phase) modulating signal of I/Q modulation.



It is used to output the I (In-Phase) components of the I/Q modulation of the built-in baseband generator.



It is used to output the Q (Quadrature Phase) components of the I/Q modulation of the built-in baseband generator.

## To Use DSG3000B for the First Time

### To Connect the Power Supply

Please connect the signal generator to AC power supply using the power cord supplied in the accessories as shown in the figure below. This signal generator supports 100-240 V, 45-440 Hz; 100-240 Vac, 45-65 Hz. The power consumption of the instrument cannot exceed 100 W. When the signal generator is connected to AC power supply via this connector, the instrument selects the correct voltage range automatically and users do not need to select the voltage range manually.

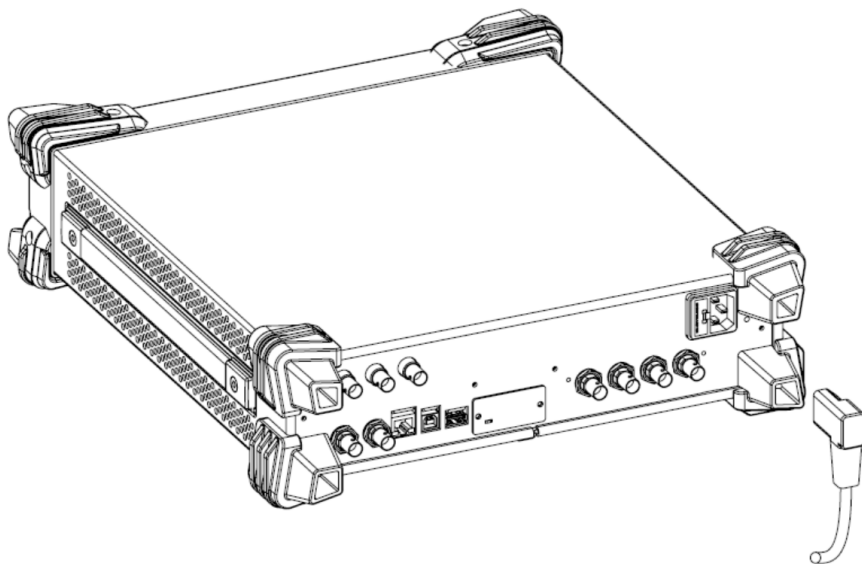



Figure 1-6 To Connect the Power Supply



#### **CAUTION**

To avoid electric shock, use the standard power cable.

### Turn-on Checkout

After the power supply is correctly connected, press the power key  on the front panel to turn on the signal generator. During the start-up, the instrument performs initialization and self-test. After that, the instrument enters the default interface.

## To Set the System Language

DSG3000B series RF signal generator supports multiple system languages. You can press **System** → **Language** to switch the system language.

## To Replace the Fuse

To replace the fuse, please use the specified fuse and follow the steps below.

1. Turn off the instrument, cut off the power and remove the power cord.
2. Insert a slotted screwdriver into the slot of the fuse holder to pry it out.
3. Take out the fuse.
4. Replace the old fuse with a specified fuse (AC 250 V, T3.15 A).
5. Install the fuse holder.

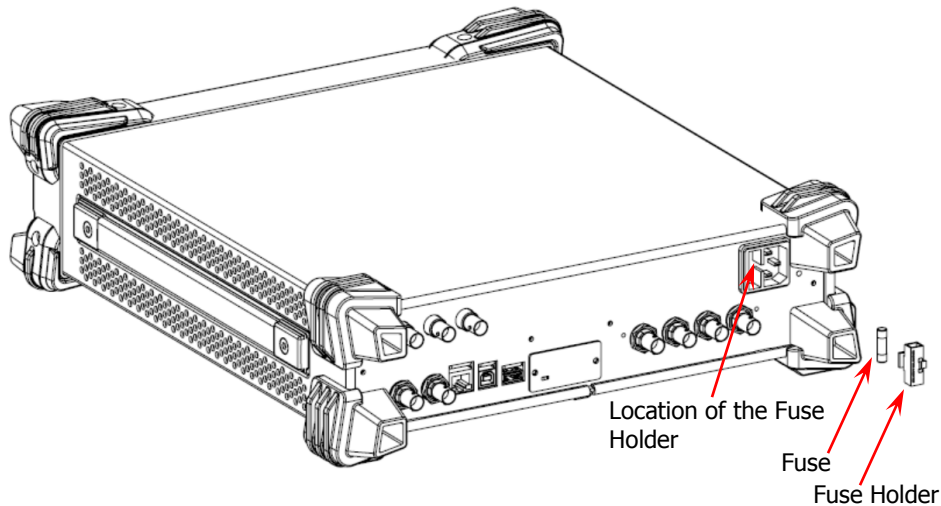

Figure 1-7 To Replace the Fuse



### **WARNING**

To avoid electric shock, make sure that the instrument is turned off, the power supply is disconnected and the fuse used is up to standard before replacing the fuse.



## User Interface

The user interface of DSG3000B series RF signal generator provides two display modes: normal display mode and parameter zoom-in mode. At power-on, the instrument enters the normal display mode by default. In this manual, the normal display mode of DSG3136B-IQ is taken as an example to illustrate the user interface of the instrument.

### Normal Display Mode

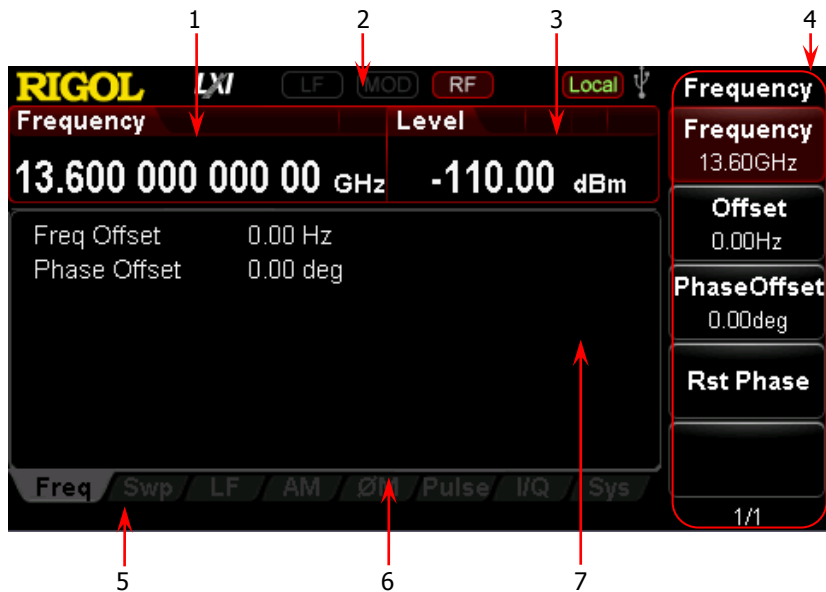

Figure 1-8 User Interface (Normal Display Mode)





#### 1. Frequency Area

Display the current frequency setting of the RF signal generator.

- **Offs** : Displayed when the frequency offset is not 0 Hz.
- **↻** : Continuous sweep label. Displayed when the sweep type is "Freq" or "Freq&Lev" and the sweep mode is "Cont".
- **→** : Single sweep label. Displayed when the sweep type is "Freq" or "Freq&Lev" and the sweep mode is "Single".
- **↑** : Forward sweep label. Displayed when the sweep type is "Freq" or "Freq&Lev" and the sweep direction is "Fwd".
- **↓** : Down sweep label. Displayed when the sweep type is "Freq" or "Freq&Lev" and the sweep direction is "Down".
- **▬** : Frequency sweep progress bar. Displayed when the sweep type is "Freq" or "Freq&Lev".









## 2. Status Bar

Indicate the states of some of the RF signal generator functions.

-  : Displayed when the LF output is enabled. This is grayed out when the LF output is disabled.
-  : Displayed when the RF modulation output is enabled. This is grayed out when the RF modulation output is disabled.
-  : Displayed when the RF output is enabled. This is grayed out when the RF output is disabled.
-  : The RF signal generator is operating in remote control mode.
-  : The RF signal generator is operating in local mode.

## 3. Amplitude Area

Display the current level setting of the RF signal generator.

-  : Displayed when the flatness calibration switch is "On".
-  : Displayed when the equal level switch is "On".
-  : Displayed when the amplitude offset is not 0 dB.
-  : Continuous sweep label. Displayed when the sweep type is "Level" or "Freq&Lev" and the sweep mode is "Cont".
-  : Single sweep label. Displayed when the sweep type is "Level" or "Freq&Lev" and the sweep mode is "Single".
-  : Forward sweep label. Displayed when the sweep type is "Level" or "Freq&Lev" and the sweep direction is "Fwd".
-  : Down sweep label. Displayed when the sweep type is "Level" or "Freq&Lev" and the sweep direction is "Down".
-  : Amplitude sweep progress bar. Displayed when the sweep type is "Level" or "Freq&Lev".

## 4. Menu Display Area

The menus in this area correspond to the softkeys at the right of the screen. Pressing any softkey can enable the corresponding menu function.

## 5. Message Display Area

Display the operation error messages and prompt messages. You can press

**System** → **Information** → **System Msg** to view the messages. When multiple messages are generated, you can use the up/down arrow keys or knob to select the message row to be viewed. When the messages cannot be displayed completely in the list, press **Verbose** to view the complete information of the current row selected in the message list.

## 6. Function Status Area

Display the current active states of each function. Each function corresponds to at most four kinds of states as shown in the table below.

Type	Remarks	Example
Gray text on a black background	The function is not selected and enabled.	
Black text on a gray background	The function is selected and you can set the corresponding parameters.	
White text on a gray background	The function is selected and enabled.	
White text on a black background	The function is not selected but it is enabled.	

The status labels in the function status area as shown in the figure below.

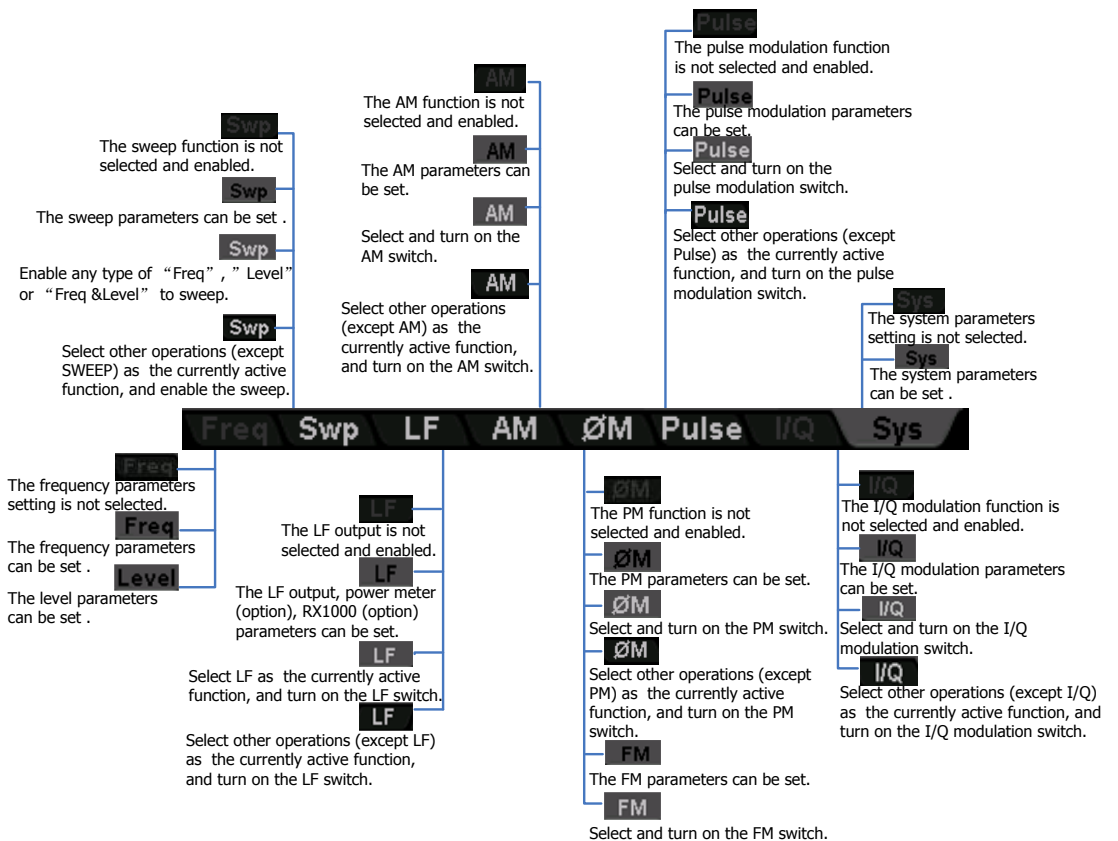

Figure 1-9 Labels in Function Status Area

## 7. Text Display Area

Display the corresponding parameter information of the current function of the RF signal generator.

## Parameter Zoom-in Mode

In normal display mode, pressing the display switch key **View** at the left of the screen can switch to the parameter zoom-in mode as shown in the figure below.



Figure 1-10 User Interface (Parameter Zoom-in Mode)

## To Use the Built-in Help System

The DSG3000B built-in help system provides help information for all the function keys and menu softkeys located on the front panel. Users can view the help of any key when operating the instrument.

### 1. Acquire the built-in help

Press **Help** and the prompt message about how to acquire the help information is displayed in the test display area of the user interface, as shown in Figure 1-11. Then, press the desired key and the help information of that key is displayed in the text display area.

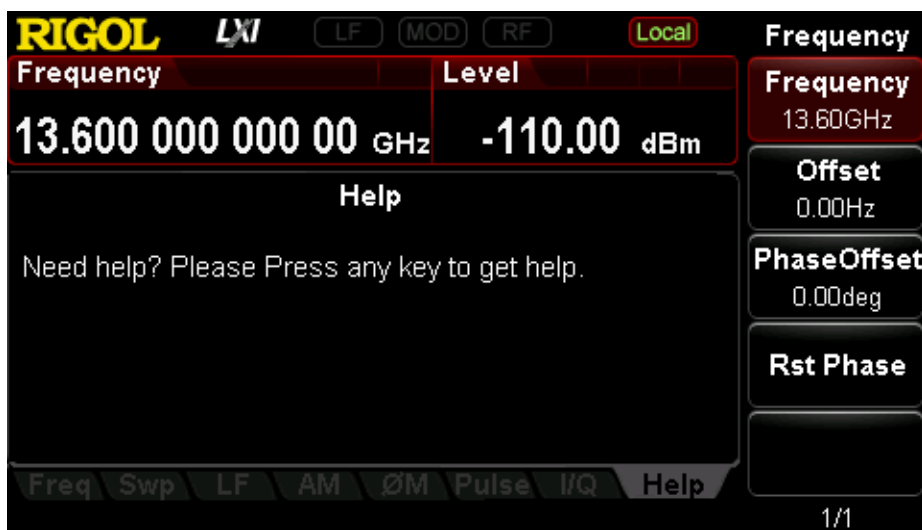

Figure 1-11 Help Interface

### 2. Page up/down

When the help information is displayed on multiple pages, users can acquire the help information on the previous or next page using the arrow keys or knob.

### 3. Turn off the current help information

When the help information is displayed in the text display area, pressing any key (except the arrow keys and knob) on the front panel will turn off the help information currently displayed.

### 4. Acquire the help information of a menu softkey

Press **Help** and help information is displayed in the text display area. Then, press the desired menu softkey, the help information of the menu item corresponding to this menu softkey is displayed in the text display area.

### 5. Acquire the help information of any function key

Press **Help** and help information is displayed in the text display area. Then,

press any function key and the function help information of this key is displayed in the text display area.

## Chapter 2 Front Panel Operations

This chapter introduces each function key on the front panel and the menu functions under it in details.

The contents of this chapter are as follows:

- To Set the Frequency Parameters
- To Set the Amplitude Parameters
- Sweep
- Modulation
- LF Output
- Store and Recall
- To Set the System Parameters

# To Set the Frequency Parameters

## Frequency

Set the RF output frequency.

Press **FREQ** → **Frequency**, then use the numeric keyboard to input the value of the frequency and select the desired unit from the pop-up unit menu or unit keys.

- The frequency units available are GHz, MHz, kHz and Hz.
- Press **Enter** to select the current frequency unit by default.
- You can also press the left/right arrow keys to enter the parameter editing state and move the cursor to the specified digit; and then use the up/down arrow keys or knob to modify the value.
- After the frequency is set, you can use the up/down arrow keys or knob to modify the frequency at the current step.
- Press **FREQ** → **Frequency** and then press **Step** to set the step.

## Frequency Offset

Set the frequency offset relative to the RF output frequency.

When using an external mixer and other devices, you can set and read the frequency value through the external mixer on the RF source by setting the frequency offset.

Press **FREQ** → **Offset**, then use the numeric keyboard to input the value of the frequency offset and select the desired unit from the pop-up unit menu or unit keys.

- The frequency offset units available are GHz, MHz, kHz and Hz.
- Press **Enter** to select the default unit (MHz).
- You can also press the left/right arrow keys to enter the parameter editing state and move the cursor to the specified digit; and then use the up/down arrow keys or knob to modify the value.
- You can also use the up/down arrow keys or knob to modify the frequency offset at the current step.
- Press **FREQ** → **Offset** and then press **Step** to set the step.

### Remarks

1. When the frequency offset is 0 Hz, the frequency displayed in the interface (namely setting frequency) is equal to the actual output frequency.
2. When frequency offset is not 0 Hz, the output frequency is determined by setting frequency and frequency offset. The three parameters satisfy the equation: setting frequency (display frequency) = output frequency + frequency offset
3. The deviation (namely the actual output frequency) between interface display frequency and frequency offset cannot exceed the frequency range of instrument.



## Phase Offset

Set the phase offset of the RF signal.

When multiple RF signal generators are used to output signals, you can adjust the phase offset of the instrument to synchronize the phase or set a fixed phase offset for the signals.

Press **FREQ** → **Phase Offset**, then use the numeric keyboard to input the value of the phase offset, and press **deg** or the unit key.

- Press **Enter** to select the default unit (deg).
- Press the left/right arrow keys to enter the parameter editing state.
- You can also use the up/down arrow keys or knob to modify the phase offset at the current step.
- Press **FREQ** → **Phase Offset** and then press **Step** to set the step.
- Press **Rst Phase** to reset the current phase offset to 0 deg.

## To Set the Amplitude Parameters

### Amplitude

Set the RF output amplitude.

Press **LEVEL** → **Level**, use the numeric keyboard to input the amplitude value and select the desired unit from the pop-up unit menu or unit keys.

- The amplitude units available are dBm, -dBm, mV,  $\mu$ V and nV.
- Press **Enter** to select the default unit (dBm).
- You can also press the left/right arrow keys to enter the parameter editing state and move the cursor to the specified digit and then use the up/down arrow keys or knob to modify the value.
- You can also use the up/down arrow keys or knob to modify the amplitude at the current step.
- Press **LEVEL** → **Level** and then press **Step** to set the step.

### Amplitude Limit

Set the limit of the RF output amplitude. This value is the upper limit of the RF output amplitude.

To limit the output amplitude, you can use the amplitude limit function to avoid damage caused by delivering a high-powered signal to the external circuit.

Press **LEVEL** → **Limit**, use the numeric keyboard to input the value of the amplitude limit and select the desired unit from the pop-up unit menu or unit keys.

- The amplitude limit units available are dBm, -dBm, mV,  $\mu$ V and nV.
- Press **Enter** to select the default unit (dBm).
- You can also press the left/right arrow keys to enter the parameter editing state and move the cursor to the specified digit; and then use the up/down arrow keys or knob to modify the value.
- You can also use the up/down arrow keys or knob to modify the amplitude limit at the current step.
- Press **LEVEL** → **Limit** and then press **Step** to set the step.

## Amplitude Offset

Set the amplitude offset relative to the RF output amplitude.

If the external device or circuit has a fixed attenuation or gain, you can set and read the amplitude value after through the external device or circuit on the RF source by setting the amplitude offset.

Press **LEVEL** → **Offset**, use the numeric keyboard to input the amplitude offset value and press **dB** or the unit key.

- The amplitude offset unit available is dB.
- Press **Enter** to select the default unit (dB).
- You can also press the left/right arrow keys to enter the parameter editing state and move the cursor to the specified digit and then use the up/down arrow keys or knob to modify the value.
- You can also use the up/down arrow keys or knob to modify the amplitude offset at the current step.
- Press **LEVEL** → **Offset** and then press **Step** to set the step.

### Remarks

1. When amplitude offset is 0 Hz, the amplitude displayed in the interface (namely setting amplitude) is equal to the actual output amplitude.
2. When amplitude offset is not 0 Hz, output amplitude is determined by setting amplitude and amplitude offset. The three parameters satisfy the equation: setting amplitude (display amplitude) = output amplitude + amplitude offset
3. The deviation (namely the actual output amplitude) between interface display amplitude and amplitude offset cannot exceed the amplitude range of instrument.
4. The current amplitude range of instrument is related to the amplitude limit and RF output frequency.

## Flatness Calibration

The flatness calibration function can adjust the RF output amplitudes corresponding to the frequency points within the frequency range of the instrument to compensate for the external loss caused by the cables, switches or other devices. You can load the flatness calibration lists stored in the internal or external memory to DSG3000B and view the list contents.

### 1. Set the flatness calibration state

Press **LEVEL** → **Flatness** → **Switch** to set the flatness calibration to "On" or "Off". When the flatness calibration is enabled, the UF label will be displayed in the amplitude area in the user interface.

### 2. Create the flatness calibration list

Press **LEVEL** → **Flatness** → **Cal List** to enter the flatness calibration list menu.

Load a list

Press **Load** to open the store and recall interface. At this point, you can select and read the flatness calibration list files stored. For the detailed operations, refer to "**Store and Recall**".

The format of the calibration list file loaded is as shown in the table below. Note that while you edit the value in the flatness calibration list, if no unit is added, then the default frequency unit is mHz and the default amplitude unit is dB.

SN	Freq	Level <sup>[1]</sup>
1	207.854 000 00 MHz	-70.50 dB
2	304.000 000 00 MHz	7.45 dB
3	800.000 000 00 MHz	-17.80 dB

**Note<sup>[1]</sup>:** Amplitude calibration value. When calibrating the amplitude of the current frequency point, only the actual output amplitude will be affected and the amplitude display value will not change.

## Amplitude Unit

Set the unit of the RF output amplitude.

Press **LEVEL** → **Level Unit** and select the desired unit from the pop-up unit menu. The output amplitude units available are dBm, dBmV, dBuV, Volts and Watts. Wherein, dBm, dBmV and dBuV are logarithmic units; Volts and Watts are linear units. The default is dBm.

## Sweep

When the sweep function is enabled, the RF signal generator outputs RF sweep signal from the **[RF OUTPUT 50Ω]** connector (as shown in the figure below) on the front panel (at this point, RF output switch is turned on).



**NOTE:** The Sweep function and I/Q Modulation function cannot be enabled at the same time. If the IQ Modulation has already been enabled before you enable the Sweep function, then once you enable the Sweep function, the IQ Modulation will be disabled automatically.

## Sweep Manner

DSG3000B provides three sweep manners ("Freq", "Level" and "Freq & Lev"). The sweep function is enabled when any of the sweep manners is selected and the Swp label will be displayed in the function status area in the user interface. By default, the sweep function is turned off.

Press **[SWEEP]** → **Sweep** to select the desired manner.

- Off: the default state. Turn off the sweep function.
- Freq: enable the frequency sweep function. At this point, the frequency sweep progress bar is displayed in the frequency area in the user interface.
- Level: enable the amplitude sweep function. At this point, the amplitude sweep progress bar is displayed in the amplitude area in the user interface.
- Freq & Lev: enable the frequency and amplitude sweep functions at the same time. At this point, the frequency and amplitude sweep progress bars are displayed in the frequency and amplitude areas in the user interface respectively.

## Sweep Direction

Press **[SWEEP]** and use the page up/down key  to open the 3/3 menu page; then, press **Direct** to select "Fwd" or "Down" and the default is "Fwd".

- Fwd: the RF signal generator sweeps from the start frequency or start level to the stop frequency or stop level. The progress bar in the frequency area and

amplitude area in the user interface sweeps from left to right.

- Down: the RF signal generator sweeps from the stop frequency or stop level to the start frequency or start level. The progress bar in the frequency area and amplitude area in the user interface sweeps from right to left.

## Sweep Type

DSG3000B provides two sweep types ("List" and "Step") and the default is "Step".

### List Sweep

#### 1. Select the list sweep mode

Press **SWEEP** → **Type** to select "List". At this point, the RF signal generator sweeps according to the current sweep list.

#### 2. Create the sweep list

Press **SWEEP** and use the page up/down key  to open the 2/3 menu page; then, press **List Swp** to enter the editing interface of sweep list.

Load a list

Press **Load** to open the store and recall interface. At this point, you can select and read the sweep list files stored. For the detailed operations, refer to "**Store and Recall**".

The format of the sweep list file loaded is as shown in the table below. Note that when you edit the value in the sweep list, the unit must be added. If no unit is added, then you may fail to load the list.

SN	Freq	Level <sup>[1]</sup>	Time <sup>[2]</sup>
1	2.000 000 000 10 GHz	-10.00 dBm	500.00 ms
2	1.994 152 687 00 GHz	-50.00 dBm	500.00 ms
3	1.888 000 000 00 GHz	-60.85 dBm	500.00 ms

**Note<sup>[1]</sup>:** The amplitude corresponding to the frequency point set.

**Note<sup>[2]</sup>:** The duration of a sweep step.

### Step Sweep

#### 1. Select the step sweep mode

Press **SWEEP** → **Type** to select "Step". At this point, the RF signal generator performs a step sweep according to the current settings.

#### 2. Set the sweep parameters

Press **SWEEP** and use the page up/down key  to open the 2/3 menu page; then, press **Step Swp** to set the start frequency, stop frequency, start level,

stop level, sweep points and so on.

- **Start Frequency**  
Press **Start Freq**, use the numeric keyboard to input the start frequency value and select the desired unit from the pop-up unit menu or unit keys. You can also press **Enter** to select the default unit (MHz).
- **Stop Frequency**  
Press **Stop Freq**, use the numeric keyboard to input the stop frequency value and select the desired unit from the pop-up unit menu or unit keys. You can also press **Enter** to select the default unit (MHz).

#### Remarks

The start frequency and stop frequency are the frequency upper and lower limits of the frequency sweep.

- When the sweep direction is forward, the RF signal generator sweeps from the start frequency to the stop frequency.
- When the sweep direction is down, the RF signal generator sweeps from the stop frequency to the start frequency.

When the "Start Freq" or "Stop Freq" is modified, the RF signal generator will restart the sweep and output from the specified "Start Freq" or "Stop Freq".

- **Start Level**  
Press **Start Lev**, use the numeric keyboard to input the start level value and select the desired unit from the pop-up unit menu or unit keys. You can also press **Enter** to select the default unit (dBm).
- **Stop Level**  
Press **Stop Lev**, use the numeric keyboard to input the stop level value and select the desired unit from the pop-up unit menu or unit keys. You can also press **Enter** to select the default unit (dBm).

#### Remarks

The start level and stop level are the amplitude upper and lower limits of the amplitude sweep.

- When the sweep direction is forward, the RF signal generator sweeps from the start level to the stop level.
- When the sweep direction is down, the RF signal generator sweeps from the stop level to the start level.

When the "Start Lev" or "Stop Lev" is modified, the RF signal generator will restart the sweep and output from the specified "Start Lev" or "Stop Lev".

- **Sweep Points**  
Press **Points**, use the numeric keyboard to input the number of sweep

points and then press **OK** or **Enter**.

- Dwell Time

The dwell time indicates the duration of a sweep step.

Press **Dwell Time**, use the numeric keyboard to input the time value and select the desired unit from the pop-up unit menu or unit keys. You can also press **Enter** to select the default unit (s).

- Sweep Space

The sweep space indicates the mode in which the instrument changes from one frequency or amplitude to another within one step.

Press **Swp Space** to select "Log" or "Lin" sweep space. Note that the level sweep only supports the "Lin" sweep space.

- Sweep Shape

The sweep shape indicates the cycle mode of multiple sweeps.

Press **Shape** to select "Ramp" or "Triangle" sweep shape. When the sweep direction is "Fwd", the "Ramp" and "Triangle" sweep shapes are as shown in the figure below.

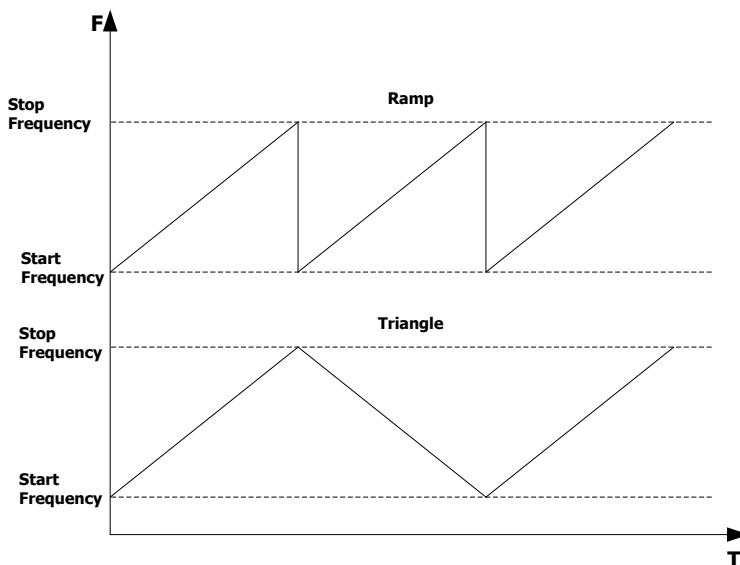

Ramp: the sweep period always starts from the start frequency or start level to the stop frequency or stop level and the sweep sequence is similar to a ramp waveform.

Triangle: the sweep period always starts from the start frequency or start level to the stop frequency or stop level and then returns back to the start frequency or start level. The sweep sequence is similar to a triangle



waveform.

## Sweep Mode

Press **SWEEP** → **Mode** to select "Cont" or "Single" sweep and the default is "Cont".

- Cont: after selecting continuous sweep, the continuous sweep label is displayed in the frequency or amplitude area in the user interface. When the trigger condition is met, the instrument starts to sweep continuously according to the current setting.
- Single: after selecting single sweep, the single sweep label is displayed in the frequency or amplitude area in the user interface. When the trigger condition is met, the instrument performs one sweep according to the current setting and then stops.

## Single Sweep

If the current sweep mode is "Cont", press **Single** to switch the sweep mode to "Single" and the instrument will perform one sweep if the trigger condition is met. If the current sweep mode is "Single", press **Single** and the instrument will perform one sweep if the trigger condition is met.

## Reset Sweep

If the current sweep direction is "Fwd", press **Reset Swp**, the instrument stops the current sweep and restarts the sweep from the start frequency or start level. If the current sweep direction is "Down", press **Reset Swp**, the instrument stops the current sweep and restarts the sweep from the stop frequency or stop level.

## Trigger Mode

### 1. Trigger Mode

Select the trigger mode of the whole sweep period.

Press **SWEEP** and use the page up/down key  to open the 2/3 menu page; then, press **Trig Mode** to select "Auto", "Key", "Bus" or "Ext" trigger.

**NOTE:** The following descriptions are valid when the trigger mode of each point in the sweep period is met.

- **Auto Trigger**  
The default mode is auto. If the sweep mode is set to "Cont", the instrument will start sweeping once a sweep type is selected. If the sweep mode is set to "Single", press **Single** to meet the single sweep condition. The instrument will start a sweep and then stops.
- **Key Trigger**  
After selecting "Key" trigger, if the sweep mode is set to "Cont", the instrument starts a sweep each time **Trigger** on the front panel is pressed. If the sweep mode is "Single", press **Single** to meet the single sweep condition. After that the instrument starts a sweep and then stops each time **Trigger** on the front panel is pressed.
- **Bus Trigger**  
After selecting "Bus" trigger, if the sweep mode is set to "Cont", the instrument starts a sweep each time the "\*TRG" command is sent. If the sweep mode is "Single", press **Single** to meet the single sweep condition. After that the instrument starts a sweep and then stops each time the "\*TRG" command is sent.
- **External Trigger**  
In external trigger, the RF signal generator accepts the trigger signal input from the **[TRIGGER IN]** connector (as shown in the figure below) on the rear panel. If the sweep mode is set to "Cont", the instrument starts a sweep each time a TTL pulse signal with specified polarity is received. If the sweep mode is "Single", press **Single** to meet the single sweep condition. After that the instrument starts a sweep and then stops each time a TTL pulse signal with the specified polarity is received.



To specify the polarity of the TTL pulse signal, press **Trig Slope** to select "Pos" or "Neg" and the default is "Pos".

## 2. Point Trigger Mode

Select the trigger mode of each sweep point in a sweep period.

Press **SWEEP** and use the page up/down key  to open the 2/3 menu page; then, press **Point Trig** to select "Auto", "Key", "Bus" or "Ext" trigger.

**NOTE:** The following descriptions are valid when the corresponding trigger mode of sweep period is met.

- **Auto Trigger**  
The default mode is auto. If the sweep mode is set to "Cont", the instrument will start sweeping each sweep point continuously within a sweep period once a sweep type is selected. If the sweep mode is set to "Single", press **Single** to meet the single sweep condition. After that the instrument starts to sweep and then stops after the sweep period is finished.
- **Key Trigger**  
After selecting "Key" trigger, if the sweep mode is set to "Cont", the instrument starts to sweep a point each time **Trigger** on the front panel is pressed. If the sweep mode is "Single", press **Single** to meet the single sweep condition. At this point, the instrument starts to sweep a point and stops after the sweep period is finished each time **Trigger** on the front panel is pressed.
- **Bus Trigger**  
After selecting "Bus" trigger, if the sweep mode is set to "Cont", the instrument starts to sweep a point each time the "\*TRG" command is sent. If the sweep mode is "Single", press **Single** to meet the single sweep condition. At this point, the instrument starts to sweep a point and stops after the sweep period is finished each time the "\*TRG" command is sent.
- **External Trigger**  
In external trigger mode, the RF signal generator accepts the trigger signal input from the **[TRIGGER IN]** connector (as shown in the figure below) on the rear panel. If the sweep mode is set to "Cont", the instrument starts to sweep a point each time a TTL pulse signal with specified polarity is received. If the sweep mode is "Single", press **Single** to meet the single sweep condition. At this point, the instrument starts to sweep a point and stops after the sweep period is finished each time a TTL pulse signal with specified polarity is received.



To specify the polarity of the TTL pulse signal, press **Trig Slope** to select "Pos" or "Neg" and the default is "Pos".

**Remarks**

When executing the sweep operation, the priority order of the conditions is Single Sweep → Trigger Mode → Point Trigger Mode. For example, when both the trigger mode and point trigger mode are set to "Key" trigger:

- In "Cont" sweep mode, press **Trigger** to meet the trigger mode of the whole period and then press **Trigger** again to meet the trigger mode of points within the sweep period; then, the instrument starts to sweep.
- In "single" sweep mode, press **Single** to meet the single sweep condition and then press **Trigger** twice to meet the sweep period trigger mode and point trigger mode respectively. Then, the instrument starts to sweep.

# Modulation

## Amplitude Modulation (AM)

During amplitude modulation (AM), the modulating signal changes the amplitude of the RF carrier waveform linearly. This function only supports the frequency band below 3.6 GHz.

### To Enable AM

Press **AM** → **Switch** to select "On" or "Off".

- On: enable the AM function. The backlight of **AM** lights on and the AM label is displayed in the function status area in the user interface.
- Off: disable the AM function and this is the default state.

**NOTE:** When a sweep type is selected, if the step sweep time is lower than 30 ms and amplitude modulation is turned on, "You can turn on the AM when sweep time is greater than 30ms" will be displayed in the user interface.

### To Select the Modulation Source

Press **AM** → **Source** to select "Int" or "Ext" modulation source.

#### 1. Internal Source

After selecting "Int", the internal modulation source is turned on. At this point, the instrument provides the modulating signal and you can set the modulation frequency and modulation waveform of the modulating signal.

#### 2. External Source

After selecting "Ext", **Freq** and **Waveform** are grayed out and disabled. The RF signal generator receives the external modulating signal input from the **[EXT MOD INPUT]** connector (as shown in the figure below) on the front panel. This modulating signal can be any waveform.

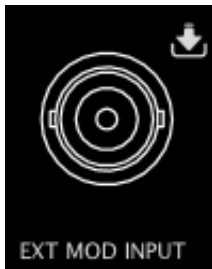

**NOTE:** The input amplitude of the external modulating signal cannot exceed +/-3 V (HighZ). To ensure the modulation performance, the input amplitude of

the external modulating signal should be less than 1 Vpp.

## To Set the Modulation Depth

The modulation depth indicates the extent of output amplitude variation and is expressed as a percentage. The range of AM modulation depth is from 0% to 100%.

Press **AM** → **Depth** to set the AM modulation depth.

### 1. Select "Int" modulation source

AM modulation depth ( $m_a$ ) and the amplitude difference ( $\Delta P_{sb}$ ) between the carrier and sidebands satisfy the following relation:

$$\Delta P_{sb} = 6 - 20 \lg m_a$$

- When modulation depth is 0%, the instrument outputs a single frequency carrier signal.
- The greater the modulation depth is, the smaller the difference between the output amplitude and carrier amplitude and the better the symmetry of the output amplitudes of the upper and lower sidebands.

### 2. Select "Ext" modulation source

- 100% modulation depth refers to the modulation depth corresponding to 1 Vpp input amplitude of the external modulation source.
- When the input amplitude of the external modulation source is 0.5 Vpp, the modulation depth actually measured is 50%.

## To Select the Modulation Waveform

Press **AM** → **Source** to select "Int" modulation source. Press **Waveform** to select "Sine" or "Square". The default is "Sine".

**NOTE:** When "Ext" modulation source is selected, this menu is grayed out and disabled.

## To Set the Modulation Frequency

Press **AM** → **Source** to select "Int" modulation source. Then press **Freq** to set the modulation frequency.

- Use the numeric keyboard or knob to input the desired frequency value.
- For sine waveforms, the range of the modulation frequency is from 10 Hz to 100 kHz.
- For square waveforms, the range of the modulation frequency is from 10 Hz to

20 kHz.

**NOTE:** When "Ext" modulation source is selected, this menu is grayed out and disabled.

## External Coupling

Press **EXT Coup** to select "AC" or "DC" coupling. The default is "AC".

- When "AC" is selected: the DC components of the external signal input from the **[EXT MOD INPUT]** connector on the rear panel of the instrument will be blocked and the AC components can pass through the connector. The external modulation input port is similar to a high-pass filter whose lower cut-off frequency is less than 5 Hz.
- When "DC" is selected: all the AC components and DC components of the external input signal can pass through the connector.

**NOTE:** When "Int" modulation source is selected, this menu is grayed out and disabled.

## Input Impedance

Press **Impedance** to select "50ohm", "600ohm" or "100kohm ". You can set the impedance of the **[EXT MOD INPUT]** input channel.

**NOTE:** When "Int" modulation source is selected, this menu is grayed out and disabled.

## Equal Level

The equal level output function is available under the **AM** menu. That is, when AM modulation is used in setting the amplitude value for the continuous waveforms, the output signal peak remains unchanged, as is shown in the following figure.

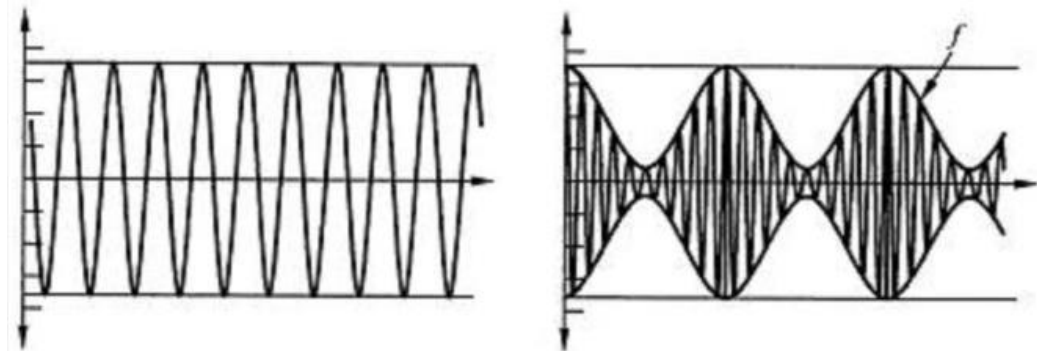

**NOTE:**

- This function is only valid when the amplitude modulation, MOD, and equal level output are enabled. It is grayed out and disabled in other states.
- When AM and other modulation functions are enabled, the equal level menu is disabled automatically and invalid.
- This function is disabled by default.

## Frequency Modulation (FM)

During frequency modulation (FM), the modulating signal changes the frequency of the RF carrier waveform. This function only supports the frequency band below 3.6 GHz.

### To Enable FM

Press **FM/øM** → **FM/øM** to select "FM" and press **Switch** to select "On" or "Off".

- On: enable the FM function. The backlight of **FM/øM** lights on and the FM label is displayed in the function status area in the user interface.
- Off: disable the FM function and this is the default state.

**NOTE:** The frequency modulation and phase modulation cannot be enabled at the same time. In addition, when a sweep type is selected, if the step sweep time is lower than 200 ms and frequency modulation is turned on, "You can turn on the FM or PM when sweep time is greater than 200ms" will be displayed in the user interface.

### To Select the Modulation Source

Press **Source** to select "Int" or "Ext" modulation source.

#### 1. Internal Source

After selecting "Int", the internal modulation source is turned on. At this point, the instrument provides the modulating signal and you can set the modulation frequency and modulation waveform of the modulating signal.

#### 2. External Source

After selecting "Ext", **Rate** and **Waveform** are grayed out and disabled. The RF signal generator receives the external modulating signal input from the **[EXT MOD INPUT]** connector (as shown in the figure below) on the front panel. This modulating signal can be any waveform.



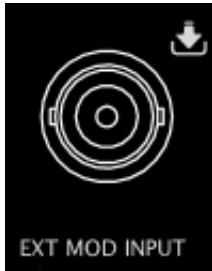

**NOTE:** The input amplitude of the external modulating signal cannot exceed  $\pm 3$  V (HighZ). To ensure the modulation performance, the input amplitude of the external modulating signal should be less than 1 Vpp.

## To Set the Frequency Deviation

The frequency deviation is the deviation of the frequency of the modulating waveform relative to that of the carrier waveform and the unit is Hz.

Press **FM/øM** → **Deviation** to set the FM frequency deviation.

- Use the numeric keyboard or the knob to input the desired frequency value.
- The different RF frequency setting corresponds to different maximum frequency deviation.

## To Select the Modulation Waveform

Press **FM/øM** → **Source** to select "Int" modulation source. Use the page Up/Down key  to open the 2/2 menu page, and then press **Waveform** to select "Sine" or "Square". The default is "Sine".

**NOTE:** When "Ext" modulation source is selected, this menu is grayed out and disabled.

## To Set the Modulation Frequency

Press **FM/øM** → **Source** to select "Int" modulation source. Then press **Rate** to set the modulation frequency.

- Use the numeric keyboard or the knob to input the desired frequency value.
- For sine waveforms, the range of the modulation frequency is from 10 Hz to 100 kHz.
- For square waveforms, the range of the modulation frequency is from 10 Hz to 20 kHz.

**NOTE:** When "Ext" modulation source is selected, this menu is grayed out and

disabled.

## External Coupling

Press **EXT Coup** to select "AC" or "DC" coupling. The default is "AC".

- When "AC" is selected: the DC components of the external signal input from the **[EXT MOD INPUT]** connector on the rear panel of the instrument will be blocked and the AC components can pass through the connector. The external modulation input port is similar to a high-pass filter whose lower cut-off frequency is less than 5 Hz.
- When "DC" is selected: all the AC components and DC components of the external input signal can pass through the connector.

**NOTE:** When "Int" modulation source is selected, this menu is grayed out and disabled.

## Input Impedance

Press **Impedance** to select "50ohm", "600ohm" or "100kohm ". You can set the impedance of the **[EXT MOD INPUT]** input channel.

**NOTE:** When "Int" modulation source is selected, this menu is grayed out and disabled.

## Phase Modulation ( $\phi$ M)

During phase modulation ( $\phi$ M), the modulating waveform changes the phase of the RF carrier waveform. This function only supports the frequency band below 3.6 GHz.

### To Enable $\phi$ M

Press **FM/ $\phi$ M** → **FM/ $\phi$ M** to select " $\phi$ M" and press **Switch** to select "On" or "Off".

- On: enable the  $\phi$ M function. The backlight of **FM/ $\phi$ M** lights on and the  $\phi$ M label is displayed in the function status area in the user interface.
- Off: disable the  $\phi$ M function and this is the default state.

**NOTE:** The frequency modulation and phase modulation cannot be enabled at the same time. In addition, when a sweep type is selected, if the step sweep time is lower than 200 ms and phase modulation is turned on, "You can turn on the FM or PM when sweep time is greater than 200ms" will be displayed in the user interface.

### To Select the Modulation Source

Press **FM/ $\phi$ M** → **Source** to select "Int" or "Ext" modulation source.

#### 1. Internal Source

After selecting "Int", the internal modulation source is turned on. At this point, the instrument provides the modulating signal and you can set the modulation frequency and modulation waveform of the modulating signal.

#### 2. External Source

After selecting "Ext", **Rate** and **Waveform** are grayed out and disabled. The RF signal generator receives the external modulating signal input from the **[EXT MOD INPUT]** connector (as shown in the figure below) on the front panel. This modulating signal can be any waveform.

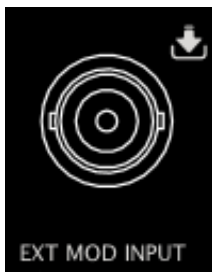

**NOTE:** The input amplitude of the external modulating signal cannot exceed +/-3 V (HighZ). To ensure the modulation performance, the input amplitude of the external modulating signal should be less than 1 Vpp.

## To Set the Phase Deviation

The phase deviation is the deviation of the phase of the modulating waveform relative to that of the carrier waveform and the unit is rad.

Press **FM/øM** → **Deviation** to set the øM phase deviation.

- Use the numeric keyboard or knob to input the desired phase value.
- The different RF frequency setting corresponds to different maximum phase deviation.

## To Select the Modulation Waveform

Press **FM/øM** → **Source** to select "Int" or "Ext" modulation source; use the page up/down key  to open the 2/2 menu page and press **Waveform** to select "Sine" or "Square". The default is "Sine".

**NOTE:** When "Ext" modulation source is selected, this menu is grayed out and disabled.

## To Set the Modulation Frequency

Press **FM/øM** → **Source** to select "Int" modulation source. Then press **Rate** to set the frequency of the modulating waveform.

- Use the numeric keyboard or knob to input the desired frequency value.
- For sine waveforms, the range of the modulation frequency is from 10 Hz to 100 kHz.
- For square waveforms, the range of the modulation frequency is from 10 Hz to 20 kHz.

**NOTE:** When "Ext" modulation source is selected, this menu is grayed out and disabled.

## External Coupling

Press **EXT Coup** to select "AC" or "DC" coupling. The default is "AC".

- When "AC" is selected: the DC components of the external signal input from the **[EXT MOD INPUT]** connector at the rear panel of the instrument will be blocked and the AC components can pass through the connector. The external modulation input port is similar to a high-pass filter which low cutoff frequency is less than 5 Hz.
- When "DC" is selected: all the AC components and DC components of the external input signal can pass through the connector.

**NOTE:** When "Int" modulation source is selected, this menu is grayed out and disabled.

## Input Impedance

Press **Impedance** to select "50ohm", "600ohm" or "100kohm ". You can set the impedance of the **[EXT MOD INPUT]** input channel.

**NOTE:** When "Int" modulation source is selected, this menu is grayed out and disabled.

## Pulse Modulation (Option DSG3000B-PUG)

During pulse modulation, the RF carrier waveform is modulated by the pulse signal. This function only supports the frequency band below 3.6 GHz. To enable this function, you need to install the option DSG3000B-PUG. For the installation methods, refer to introductions in "**License**".

### To Enable Pulse Modulation

Press **Pulse** → **Switch** to select "On" or "Off".

- On: enable the pulse modulation function. The backlight of **Pulse** lights on and the Pulse label is displayed in the function status area in the user interface.
- Off: disable the pulse modulation function and this is the default state.

**NOTE:** When a sweep type is selected, if the step sweep time is lower than 50 ms and pulse modulation is turned on, "You can turn on the Pulse Mode when sweep time is greater than 50ms" will be displayed in the user interface.

### To Select the Modulation Source

Press **Pulse** → **Source** to select "Ext" or "Int" modulation source.

#### 1. Internal Source

After selecting "Int", the internal modulation source is turned on. At this point, the instrument provides the modulating signal and you can set the pulse mode, pulse period and pulse width of the modulating signal.

#### 2. External Source

After selecting "Ext", **Mode**, **Period**, **Width**, **Trig Mode**, and **Pulse Out** are grayed out and disabled. The RF signal generator receives the external pulse signal input from the **[PULSE IN/OUT]** connector (as shown in the figure below) on the rear panel as the modulating signal.



## To Select the Pulse Mode

Press **Pulse** → **Source** to select "Int" modulation source. Then press **Mode** to select "Single" or "Train".

- Single: only one pulse signal is generated for a pulse period. This is the default pulse mode.
- Train: multiple pulse signals are generated for a pulse period. At this point, **Period** and **Width** are grayed out and disabled. You can press **Train List** to load the desired pulse train.

**NOTE:** When "Ext" modulation source is selected, this menu is grayed out and disabled. When selecting "Train" or loading "Train List", you need to install the option DSG3000B-PUG. For the specific installation methods, please refer to "**License**".

## To Set the Pulse Period

The pulse period is the time interval between two neighboring pulses in periodically-repeating pulse sequence.

Press **Pulse** → **Source** to select "Int" modulation source. Then press **Period** to set the period of the "Single" pulse modulating signal.

- Use the numeric keyboard to input the desired value and select the desired unit from the pop-up unit menu or unit keys. You can also press **Enter** to select the default unit (s).
- You can also use the Up/Down arrow keys or the knob to modify this parameter.
- The range of pulse period is from 40 ns to 170 s.
- The pulse period determines the repeating frequency of the internal pulse modulating signal.

**NOTE:** When "Ext" modulation source or "Train" pulse mode is selected, this menu is grayed out and disabled.

## To Set the Pulse Width

The pulse width is the time that the pulse can hold at the maximum value.

Press **Pulse** → **Source** to select "Int" modulation source. Then press **Mode** to select "Single". The single pulse is as shown in the figure below.

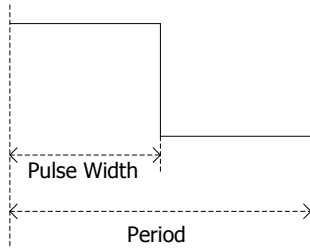

Press **Width** to set the width of the single-pulse modulating signal.

- Use the numeric keyboard or knob to input the desired pulse width value.
- The range of the pulse width is from 10 ns to (170 s – 10 ns).
- The pulse width is limited by the minimum pulse width and pulse period.  
 $\text{Pulse Width} \geq \text{Minimum Pulse Width}$   
 $\text{Pulse Width} \leq \text{Pulse Period} - 10 \text{ ns}$

**NOTE:** When "Ext" modulation source or "Train" pulse mode are selected, the above-mentioned menus are grayed out and disabled. For the "Train" pulse width and the settings of the related parameters, refer to "**Pulse Train List**".

## To Select the Trigger Mode

Press **Pulse** → **Source** to select "Int" modulation source. Then press **Trig Mode** to select "Auto", "Ext Trig", "Ext Gate", "Key", or "Bus" trigger mode.

- **Auto**  
 The default mode is auto. The RF signal generator meets the trigger condition at any time and will start the pulse modulation once the **Pulse** function is enabled.
- **External Trigger**  
 In external trigger, the RF signal generator receives the external trigger signal input from the **[TRIGGER IN]** connector (as shown in the figure below) on the rear panel. The instrument starts a pulse modulation each time a TTL pulse signal with a specified polarity is received. To specify the polarity of the TTL pulse, press **Trig Slope** to select "Pos" or "Neg". The default is "Pos".

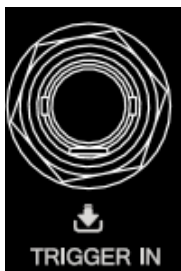



- **External Gate**

In external gate mode, the RF signal generator receives the external gated signal input from the **[TRIGGER IN]** connector on the rear panel. The instrument starts a pulse modulation within the valid level range each time a gated signal with a specified polarity is received (as shown in the figure below). To specify the polarity of the gated signal, press **Gate Polar** to select "Normal" or "Inverse". The default is "Normal".

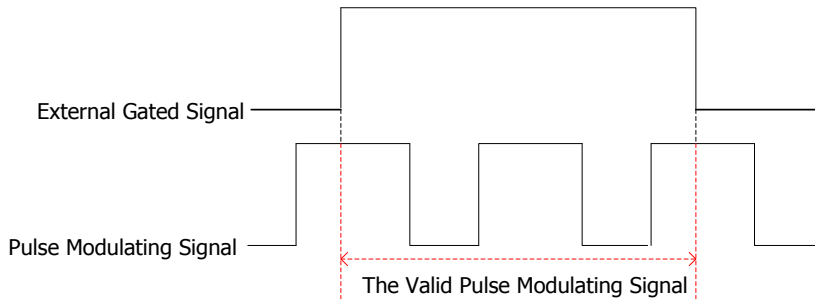

- **Key Trigger**

In key trigger mode, the instrument starts a pulse modulation each time **Trigger** on the front panel is pressed.

- **Bus Trigger**

In bus trigger mode, the instrument starts a pulse modulation each time the "\*TRG" command is sent.

**NOTE:** When "Ext" modulation source is selected, the above-mentioned menus are grayed out and disabled.

## Pulse Output

Press **Pulse** → **Source** to select "Int" modulation source. Then press **Pulse Out** to select "On" or "Off".

- On: enable the pulse output function. At this point, the RF signal generator can output the pulse signal generated by internal pulse generator from the **[PULSE IN/OUT]** connector on the rear panel. Note, this output signal is related to **Mode** settings.
- Off: disable the pulse output function and this is the default state.

**NOTE:** When "Ext" modulation source is selected, this menu is grayed out and disabled.

## Trigger Delay

Press **Pulse** → **Source** to select "Int" modulation source. After selecting **Ext Trig** mode, press **Trig Delay** set the delay from the start of receiving the external trigger signal to the start of the #1 pulse of the pulse modulating signal, as shown in the following below.

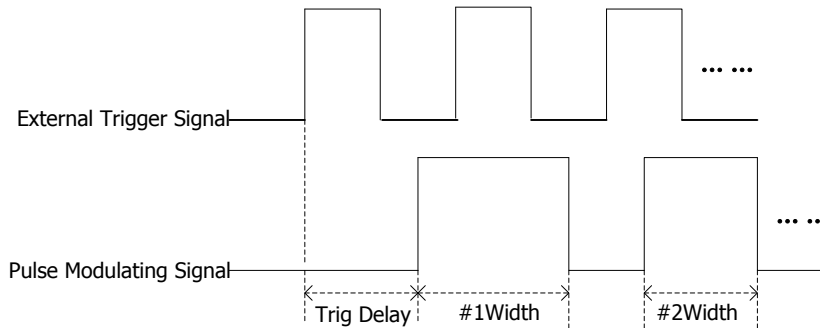

- Use the numeric keyboard or knob to input the desired trigger delay value.
- The range of the trigger delay is from 10 ns to 170 s.

**NOTE:** When "Ext" modulation source is selected, this menu is grayed out and disabled.

## To Set the Polarity

Press **Pulse** → **Polarity** to select "Normal" or "Inverse" to set the polarity of the current pulse modulating signal. The default is "Normal".

## Pulse Train List

Press **Train List** to enter the train list menu.

Load a list

Press **Load** to open the store and recall interface. At this point, you can select and read the train list files stored. For the detailed operations, refer to "**Store and Recall**".

The format of the train list file loaded is as shown in the table below. Note that when you edit the value in the train list, if no unit is added, then the default time unit is us.

SN <sup>[1]</sup>	OnTime <sup>[2]</sup>	OffTime <sup>[3]</sup>	Repeat <sup>[4]</sup>	DwellTime <sup>[5]</sup>
1	4.00 ms	5.00 ms	2	18.00 ms
2	2.00 ms	4.00 ms	5	30.00 ms
3	15.55 ms	100.5 us	2	31.30 ms

**Note**<sup>[1]</sup>: The number of the pulse set.

**Note**<sup>[2]</sup>: The duration of the high level corresponding to the pulse set.

**Note**<sup>[3]</sup>: The duration of the low level corresponding to the pulse set.

**Note**<sup>[4]</sup>: The number of repetitions of the pulse set.

**Note**<sup>[5]</sup>: The duration of the pulse currently set.

The pulse train (the number of repetitions of pulse 1 is 2) loaded is as shown in the figure below.

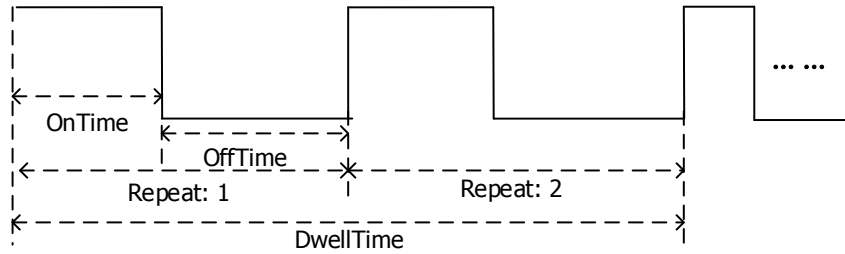

**Tip:** To load the train list, you need to install the option DSG3000B-PUG. For the installation methods, refer to "**License**".

## I/Q Modulation

I/Q modulation can improve the spectrum utilization. In IQ modulation, two orthogonal carrier signals (with the same frequency and 90° phase difference, generally expressed with Sin and Cos) are modulated with the I (In-Phase component) and Q (Quadrature Phase component) signals respectively and then they are transmitted together. This function is only available for DSG3065B-IQ and DSG3136B-IQ. This function only supports the frequency band below 6.5 GHz.

### To Enable I/Q Modulation

Press **I/Q** → **Switch** to select "On" or "Off".

- On: enable the I/Q modulation function. The backlight of **I/Q** lights on, and the I/Q label is displayed in the function status area in the user interface.
- Off: disable the I/Q modulation function and this is the default state.

**NOTE:** When a sweep type is selected, if the step sweep time is smaller than 50 ms and I/Q modulation is turned on, "You can turn on the IQ Mode when sweep time is greater than 50ms" will be displayed in the user interface.

### To Select the Modulation Source

Press **I/Q** → **Source** to select "Int" or "Ext" modulation source.

#### 1. Internal Source

When "Int" is selected, the built-in baseband generator (wavetable) provides the modulating signal. At this point, if the baseband output switch is turned on, the RF signal generator will output the I (In-Phase) components and Q (Quadrature Phase) components of the I/Q modulation baseband signal from the **[I OUT]** and **[Q OUT]** connectors (as shown in the figures below) on the rear panel.

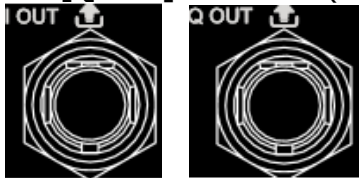

#### 2. External Source

When "Ext" is selected, the RF signal generator receives the in-phase baseband signal and quadrature phase modulating signal of the I/Q modulation input from the **[I IN]** and **[Q IN]** connectors (as shown in the figures below) on the rear panel.

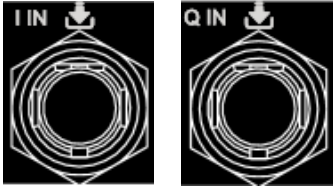

**Tip:** When an external baseband signal is input and the baseband output switch is turned on, the instrument can output the I (In-Phase) components and Q (Quadrature Phase) components of the I/Q modulation baseband signal generated by the built-in baseband generator (wavetable) from the **[I OUT]** and **[Q OUT]** connectors on the rear panel respectively.

## Baseband Signal

### 1. Baseband Output

Press **I/Q** → **BaseBand** → **Switch** to select "On" or "Off".

- On: enable the baseband output function. The RF signal generator outputs the I (In-Phase) and Q (Quadrature Phase) components of the I/Q modulation baseband signal from the **[I OUT]** and **[Q OUT]** connectors on the rear panel.
- Off: disable the baseband output function.

### 2. Baseband Level

Press **I/Q** → **BaseBand** → **Level** to set the amplitude of the baseband output signal.

- Use the numeric keyboard to input the amplitude value and select the desired unit from the pop-up unit menu or unit keys. You can also press **Enter** to select the default unit (dBm).
- The amplitude units available are V, mV,  $\mu$ V, nV and dBm.
- You can press the Left/Right arrow keys to enter the parameter editing state. Then, move the cursor to the specified digit and use the Up/Down arrow keys or the knob to modify the parameter value.
- You can also use the Up/Down arrow keys or the knob to modify the amplitude at the current step.
- Press **Step** to set the step.

**Tips:** When the baseband level unit is set to dBm, this level is converted to the value in Volts and displayed in the menu.

### 3. ARB

Press **I/Q** → **BaseBand** → **ARB** to enter the store and recall interface. At this time, the message "You can load the ARB files" is displayed in the user interface. Press **Enter** or the right direction key to unfold the current directory and select the ARB file (namely wavetable file; the format is \*.arb) to be loaded. Then press **Recall** to load this file. The message "File loading succeeded" is displayed after the file is loaded. For more information about how to load a file, please refer to "**Store and Recall**".

#### Tips:

The loadable ARB files should be edited and downloaded to DSG3000B using the Ultra IQ Station PC software. For more information about how to download the ARB file, please refer to *Ultra IQ Station\_Help Document*.

### 4. Clock Frequency

Press **I/Q** → **BaseBand** → **Clock Freq** to set the clock rate of the ARB output. You can modify this parameter by using the numeric keyboard or the knob.

- The units available are GHz, MHz, kHz and Hz.
- Press **Enter** to select the default unit (MHz).
- You can press the Left/Right arrow keys to enter the parameter editing state and move the cursor to the specified digit and use the Up/Down arrow keys or the knob to modify the parameter value.
- You can also use the Up/Down arrow keys or the knob to modify the clock frequency at the current step.
- Press **Step** to set the step.

**NOTE:** When loading the ARB file, this value will be automatically set to the clock frequency of the current ARB file.

### 5. Trigger

#### 1) Trigger Mode

Select the trigger mode of IQ modulation baseband output.

Press **Trig Mode** to select "Auto", "Key", "Bus" or "Ext".

- Auto Trigger  
This is the default mode. The RF signal generator fulfills the trigger condition at any time and it will output the IQ baseband signal continuously.
- Key Trigger  
After selecting the "Key" trigger mode, the instrument will output the

baseband signal each time **Trigger** on the front panel is pressed.

- **Bus Trigger**  
After selecting the "Bus" trigger mode, the instrument will output the baseband signal each time the \*TRG command is sent.
- **External Trigger**  
When selecting the "Ext" trigger mode, the RF signal generator receives the trigger signal input from the **[TRIGGER IN]** connector (as shown in the figure below) on the rear panel. The instrument will output the baseband signal each time a TTL pulse signal with the specified polarity is received.



## 2) Operation Mode

Select the operation mode after the I/Q modulation baseband signal is triggered.

Press **Opt Mode** to select "Retrig", "Arm Auto", "Arm Retrig" or "Single".

**NOTE:** When the "Auto" trigger mode is selected, this menu is grayed out and disabled.

- **Retrig**  
After selecting the "Retrig" mode, the instrument outputs the baseband signal continuously and restarts to output the signal each time a trigger is received.
- **Arm Auto**  
After selecting the "Arm Auto" mode, the instrument starts outputting the signal continuously each time a trigger is received until **"Arm ARB"** is selected and then waits for the next trigger.
- **Arm Retrig**  
After selecting the "Arm Retrig" mode, the instrument starts outputting

the signal continuously each time a trigger is received. The instrument restarts outputting the signal when a trigger is received until "**Arm ARB**" is selected and then waits for the next trigger.

- Single  
After selecting the "Single" mode, the instrument outputs the specified length (specified in "**Duration**") of waveform each time a trigger is received, and then stops and waits for the next trigger.

### 3) **Arm ARB**

Press **Arm ARB** to manually stop the waveform output and wait for the next trigger.

**NOTE:** This menu is valid only when the "Arm Auto" or "Arm Retrig" operation mode is selected.

### 4) **Duration Unit**

Press **Dur Unit** to select the duration unit of the IQ modulation wavetable in "Single" trigger.

- SL: take the waveform segment as the unit.
- SA: take the data point as the unit.

### 5) **Duration**

Press **Duration** to set the duration of the single trigger signal.

**NOTE:** This menu is only available when selecting the "Single" operation mode. This value defines the number of points ( $N_r$ ) and the instrument acquires the actual time ( $T_r$ ) according to the current sample rate ( $S_a$ ). They satisfy the following relation:  $T_r = N_r / S_a$ .

### 6) **External Delay**

Press **Ext Delay** to set the trigger delay when the external trigger signal is received.

**NOTE:** This menu is only available when selecting the "Ext" trigger mode. This value defines the number of points ( $N_d$ ) and the instrument acquires the actual time ( $T_d$ ) according to the current sample rate ( $S_a$ ). They satisfy the following relation:  $T_d = N_d / S_a$ .

### 7) **External Inhibit**

Press **Ext Inhibit** to set the time from when an external trigger signal is received to when the instrument receives the next trigger signal.



**NOTE:** This menu is only available when selecting the "Ext" trigger mode. This value defines the number of points ( $N_i$ ) and the instrument acquires the actual time ( $T_i$ ) according to the current sample rate ( $S_a$ ). They satisfy the following relation:  $T_i = N_i / S_a$ .

## LF Output

LF output refers to the output of the low-frequency signal generated by the internal generator of the RF signal source. LF outputs two common waveforms: Sine and Square. You can set the frequency and amplitude of the low-frequency signal.

### To Enable the LF Output

Press **LF** to enable the LF output. The backlight of the key lights on and the LF label is displayed in the status bar and the function status area in the user interface. At this point, the **[LF OUTPUT]** connector (as shown in the figure below) outputs the LF signal according to the current configuration.



### To Set the LF Parameters

Press **LF AUX** → **LF** to set the "Waveform", "Level" and "Freq" of the LF output signal.

#### To Select the LF Waveform

Press **LF AUX** → **LF** → **Waveform** to set the waveform of the LF output signal to "Sine" or "Square". The default is "Sine".

#### To Set the LF Amplitude

Press **LF AUX** → **LF** → **Level** to set the amplitude of the LF signal.

- Use the numeric keyboard to input the amplitude value and select the desired unit from the pop-up unit menu or unit keys. You can also press **Enter** to select the default unit (dBm).
- The amplitude units available are V, mV,  $\mu$ V, nV and dBm.
- You can press the Left/Right arrow keys to enter the parameter editing state and move the cursor to the specified digit and use the Up/Down arrow keys or the knob to modify the parameter value.
- You can also use the Up/Down arrow keys or the knob to modify the amplitude at the current step.

- Press **Step** to set the step.
- The settable ranges of the amplitudes of sine and square are both from 0 V to 3 V. Note that when the frequency is 0 Hz, the LF outputs a DC signal and the settable range of the amplitude is from -3 V to 3 V.

**Tips:** When the LF level unit is set to dBm, this level is converted to the value in Volts and displayed in the menu.

## To Set the LF Frequency

Press  → **LF** → **Freq** to set the frequency of the LF signal.

- Use the numeric keyboard to input the frequency value and select the desired unit from the pop-up unit menu or unit keys. You can also press **Enter** to select the default unit (MHz).
- The frequency units available are GHz, MHz, kHz and Hz.
- You can press the Left/Right arrow keys to enter the parameter editing state and move the cursor to the specified digit and use the Up/Down arrow keys or knob to modify the parameter value.
- After setting the frequency, you can use the Up/Down arrow keys or knob to modify the frequency at the current step.
- Press **Step** to set the step.

### Remarks

The settable range of sine frequency is from 0 Hz to 200 kHz.  
The settable range of square frequency is from 0 Hz to 20 kHz.

## Store and Recall

DSG3000B allows users to store various types of files to internal or external memory and recall them when required.

DSG3000B provides a local memory (D disk) and an external memory (E disk).

- D disk: provide storage locations for train list, flatness, sweep list and state files.
- E disk: available when USB storage device is detected on the USB Host interface on the rear panel. You can store the files whose types are the same as those stored in Disk D.

Press **Storage** on the front panel to enter the store and recall interface, as shown in Figure 2-1.



Figure 2-1 store and recall interface

**NOTE:** DSG3000B can recognize files whose filenames consist of Chinese characters, English characters and numbers. If other characters are used in the file or folder name, it might not be displayed in the store and recall interface normally.

## File Type

In the store and recall interface, use the Up/Down arrow keys or the knob to select the current saving directory (when USB storage device detected is available, you can switch between Disk D and Disk E). Press **Enter** or the right arrow key to unfold the current directory. Press **File Type** to select the desired file type.

The file types available are "All", "State", "Arb", "Flat csv", "Swp csv", and "Train csv".

The default is "All". The description of each file type is as shown in the table below.

File Type	Format	Suffix	Remarks
State	BIN	.STA	Store the current system state in binary format.
Arb	BIN	.arb	The arbitrary waveform <sup>[1]</sup> wavetable file stored in binary format. You can load the file when necessary.
Flat csv	CSV	.CSV	The flatness list file stored in csv format. You can open the file using Excel on the PC to view the list information.
Swp csv	CSV	.CSV	The sweep list file stored in csv format. You can open the file using Excel on the PC to view the list information.
Train csv	CSV	.CSV	The train list file stored in csv format. You can open the file using Excel on the PC to view the list information.

**Note<sup>[1]</sup>:** The wavetable files should be edited and downloaded to the RF signal generator via the Ultra IQ Station PC software.

**Tip:** You can generate csv format files using Excel on the PC. Then, you can open the file, edit the required parameter values (the unit is required to be added) according to the corresponding file format requirements directly in the Excel table and save it to a USB storage device. In addition, you can also load the file to the RF signal generator when required.

## Save

### 1. Select the file type

Please select the desired file type according to the introduction in "File Type".

**NOTE:** If **File Type** is set to "All", the save operation is not available.

### 2. Open the filename input interface

Press **Save** to enter the filename editing interface. You can press  to switch among Chinese, English and number input modes.

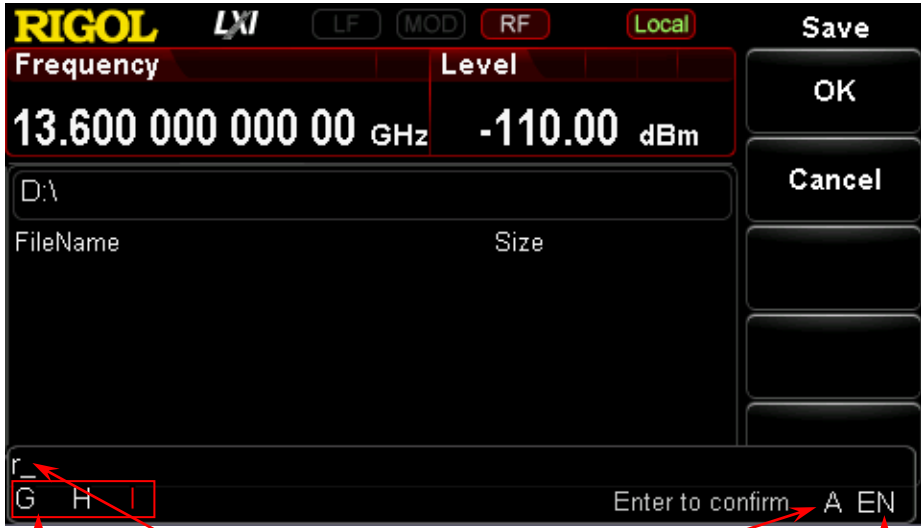

Letter Selection Area      Letters Entered      Uppercase/Lowercase      English Input Mode  
(a) English Input Mode



Numbers Entered      Number Input Mode  
(b) Number Input Mode

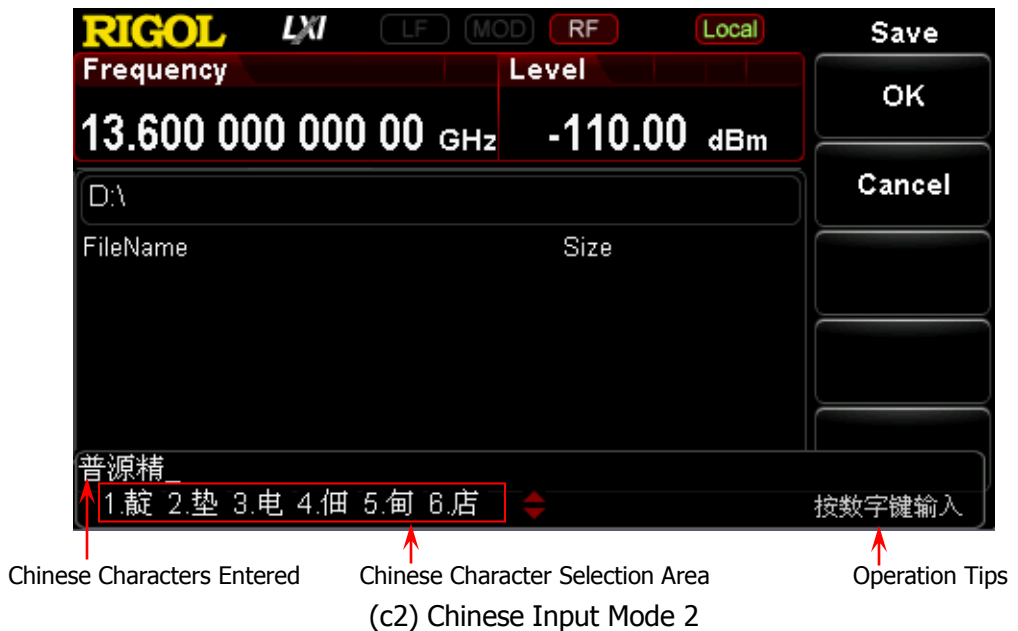
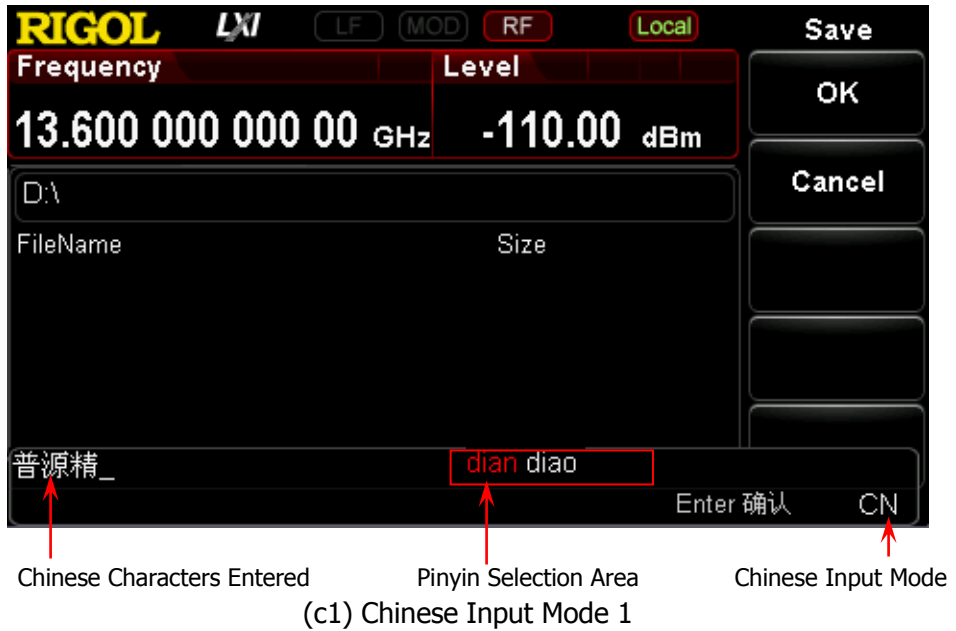



Figure 2-2 Filename Input Interface

### 3. Input the filename

Input the new filename in the filename input interface. The length of the filename cannot exceed 28 English characters or numbers (or 14 Chinese characters).

- **Input English filename**

- a) Press  to switch to English input mode. You can use  to switch between uppercase and lowercase. At this point, the corresponding label is displayed at the lower-right corner of the filename input interface.
- b) Press the key of the desired letter. At this point, the letters available are displayed in the **letter selection area**. Press this key continuously or the Left/Right arrow keys or rotate the knob until the background of the desired letter turns red. Then, press **Enter** to input the letter.
- c) Use the above method to input the other letters in the filename.

- **Input Chinese filename**

- a) Press  to switch to Chinese input mode. At this point, the corresponding label is displayed at the lower-right corner of the filename input interface.
- b) Press the key of the first letter of the pinyin of the desired Chinese character and the pinyins available are displayed in the **pinyin selection area**. If the desired pinyin is displayed, refer to step c). If the desired pinyin is not displayed, input the whole pinyin and then refer to c).
- c) Press the Left/Right arrow keys or rotate the knob until the background of the desired pinyin turns red. Press **Enter** to select that pinyin. At this point, the Chinese characters in the **Chinese character selection area** are numbered. Use the numeric keys to select the desired Chinese character. You can use the up/down arrow keys or rotate the knob to open the previous page and next page of the **Chinese character selection area**.
- d) Use the same method to input the other Chinese characters.

- **Input number filename**

If you want to use numbers as the filename (or a part of the filename),

press  to switch to number input mode and use the numeric keyboard to input the desired numbers.

#### 4. Save the file

After inputting the filename in the filename input interface, press **OK** and the RF signal generator will save the file with the specified filename in the specified file type under the directory currently selected. Press **Cancel** to cancel the save operation.

- **Replace File:** when the current path has contained a file or folder with the same name, you can press this key to replace the original file or folder.
- **Reenter:** when the current path has contained a file or folder with the same name, you can press this key to back the filename input interface and



reenter the filename.

## Recall

After selecting a file stored, press **Recall** to read the file selected and load it into the system.

## Rename

Modify the filename of the stored file.

After selecting a file stored, press **Rename** to enter the filename input interface. Edit a new filename by referring to the introduction in "**Input the filename**" and press **OK** to store the file with the new filename.

## Delete

After selecting a file stored, press **Delete** to delete the file selected.

## Copy

After selecting a file stored, press **Copy** to select "Copy" or "Paste".

### 1. Copy

Copy the file or folder selected under the current directory.

### 2. Paste

Paste the file or folder.

- When the copy path is the same as the paste path and the current path has contained a file or folder with the same name, the corresponding copy file with the "dup" prefix name is generated after performing paste operation.
- When the copy path is different from the paste path and the current path has contained a file or folder with the same name,
  - Replace File: press this key to replace the original file or folder.
  - Cancel: press this key to cancel the paste operation.

## To Create a Directory

Create a new folder. The length of the folder name cannot exceed 28 English characters or numbers (or 14 Chinese characters).

In the store and recall interface, use the Up/Down arrow keys or the knob to select the current saving directory (when USB storage device detected is available, you can switch between Disk D and Disk E). Press **Enter** or the Left/Right arrow keys to unfold the current directory. Press **Create Dir** to enter the filename input interface. To edit the folder name, refer to the introduction in "**Input the filename**". Press **OK** to create an empty folder under the current directory.

## Filename Prefix

Press **Storage** → **Name Prefix** to select "Prefix State" or "Edit Prefix".

### 1. Prefix State

Press **Prefix State** to select "On" or "Off" to enable or disable the prefix edited. When "On" is selected, the edited prefix will be added into the filename input box automatically when saving file.

### 2. Edit Prefix

Press **Edit Prefix** to enter the filename input interface and you can use the numeric keyboard to edit the prefix.

## Disk Management

Press **Storage** → **Disk Mgr** to select "Format D" or "Disk Info".

### 1. Format D

After selecting "Disk D", press **Format D** → **OK** to format the local disk.

### 2. Disk Information

Press **Disk Info** to view the disk information, including the disk name, type, file system, used space and total space.

## System Update

After selecting the update file in the USB storage device, press **Storage** → **Update** to update the software of the RF signal generator.

**Warning**

During system update, please strictly follow the instructions below.

1. In the **RIGOL** official website, find and download the specified firmware for the DSG3000B series RF signal generator.
2. Please carefully read the installation instructions and version information to determine whether the firmware matches your instrument model.
3. During system upgrade, please keep the power supply work normally. Do not disconnect the instrument from power during upgrade.
4. Do not press any key on the instrument during system upgrade.
5. Do not perform remote control over the instrument during system upgrade. It is recommended to disconnect the communication interface.
6. If any problem occurs during the upgrade process, please power off the instrument and restart it again. Then perform the upgrade operation again.

## To Set the System Parameters

Set the system-related parameters.

### Language

DSG3000B supports Chinese/English menus, help, interface display and Chinese/English input methods.

Press **System** → **Language** to select the desired language ("English" or "中文").

### Reset

Press **System** → **Reset** to perform "Power On", "Preset Type" and "Save Preset" operations.

#### 1. Power On

Press **Power On** to select "Last" or "Preset".

- When "Last" is selected, the system setting before the last power-off will be loaded automatically at power-on.
- When "Preset" is selected, the setting defined in **Preset Type** will be loaded automatically at power-on.

#### 2. Preset Type

Press **Preset Type** to select "Factory" or "User".

- When **Power On** is set to "Preset", the specified preset type will be loaded at power-on.
- After power-on, press **Preset** on the front panel under any operation interface to recall the factory setting or user setting.

#### 3. Save Preset

Press **Save Preset** to store the current system configuration as user-defined setting in the internal non-volatile memory. When **Preset Type** is set to "User", the configuration will be loaded when you recall the "Preset" configuration.

**NOTE:** When **Preset Type** is set to "Factory", this menu is grayed out and disabled.

## I/O Configuration

The RF signal generator supports LAN, USB, and USB-GPIB interface communication.

Press **System** → **I/O Config** to set the "Remote I/O", "LAN" or "GPIB" parameters.

### 1. Remote I/O

Press **Remote I/O** to select "LAN", "USB", "GPIB", "Auto" or "Off" all interfaces.

### 2. LAN

Press **LAN** to set the LAN parameters.



Figure 2-3 To Set the LAN Parameters

- **Reset**  
Turn on the DHCP and auto IP and turn off the manual IP. Clear the network password set to restore it to factory setting.
- **Apply**  
After configuring LAN parameters, press **Apply** → **OK** to apply the configuration.
- **DHCP**  
One of the IP address setting methods. Turn on the DHCP and the DHCP server will assign network parameters (such as the IP address, subnet mask and gateway) for the RF signal generator according to the current network configuration.
- **Auto-IP**  
One of the IP address setting methods. Turn on the auto IP and the RF

signal generator will acquire an IP address from 169.254.0.1 to 169.254.255.254 and subnet mask 255.255.0.0 automatically according to the current network configuration.

- **Manual-IP**  
One of the IP address setting methods. Turn on the manual IP and users can define the IP address of the RF signal generator.
  - **IP**  
Set the IP address, subnet mask and gateway manually.
    - a) Press **IP Address** and use the numeric keyboard to input the desired IP address.  
The format of the IP address is nnn.nnn.nnn.nnn. Wherein, the first segment ranges from 1 to 223 (except 127) and the other three segments range from 0 to 255. You are recommended to ask your network administrator for an available IP address.
    - b) Press **Sub Mask** and use the numeric keyboard to input the desired subnet mask.  
The format of the subnet mask is nnn.nnn.nnn.nnn. Wherein, the range of the segment "nnn" is from 0 to 255. You are recommended to ask your network administrator for an available subnet mask.
    - c) Press **Gateway** and use the numeric keyboard to input the desired gateway.  
The format of the gateway is nnn.nnn.nnn.nnn. Wherein, the first segment (nnn) ranges from 1 to 223 (except 127) and the other three segments range from 0 to 255. You are recommended to ask your network administrator for an available gateway.
- NOTE:** The RF signal generator always tries to acquire the IP address configuration in the order of DHCP, auto IP and manual IP. The three methods cannot be disabled at the same time.
- **DNS**  
Press **DNS** to set the IP address of the DNS server. The format of the DNS address is nnn.nnn.nnn.nnn. Wherein, the first segment ranges from 1 to 223 (except 127) and the other three segments range from 0 to 255. You are recommended to ask your network administrator for an available address.

### 3. GPIB

DSG3000B supports USB-GPIB (option) control. Press this key to set the GPIB address.

You can use the numeric keys, the knob or arrow keys to modify the parameter. The range is from 0 to 30.

## Display Setting

Control the screen display.

Press **System** → **Display** to set the "Scr State", "Brightness" and "Time/Date".

### 1. Screen State

Press **Scr State** to set the state of the screen.

- On: the default state. Turn on the screen.
- Off: turn off the screen. At this point, the screen stops updating and is locked. Press **Esc** to unlock the screen. Screen locking is used during remote operation mode.

### 2. Brightness

Press **Brightness** to set the brightness of the LCD backlight of the RF signal generator.

- Use the numeric keys, the knob or arrow keys to modify this parameter.
- The range of the brightness is from 0 to 7.

### 3. Time/Date

You can press **Time/Date** to set the system time of the RF signal generator.

- **Set Time**  
Set the time displayed on the RF signal generator. The input format of the time is "hhmmss".  
For example, 23:12:11 is expressed as 231211.
- **Set Date**  
Set the date displayed on the RF signal generator. The input format of the date is "YYYYMMDD".  
For example, 2014/10/21 is expressed as 20141021.
- **Time/Date**  
Turn on or off the display of the time and date.

## Power Status

Press **System** → **Power Status** to select "Default" or "Open".

- Default: after the instrument is powered on, you need to press the power key on the front panel to start the instrument.

- Open: after the instrument is powered on, the instrument starts automatically.

## Information

Press **System** → **Information** to view the "System Info", "HW Info", "System Msg" or the "Verbose" of system message.

### 1. System Information

- Model
- Serial No.
- FW Version
- Boot Version
- Option

### 2. Hardware Configuration

- RFB Version
- DB Version
- RFB FPGA
- RFB CPLD
- DB FPGA
- DB CPLD
- I/Q FPGA
- I/Q Board

### 3. System Message

Display the messages recently displayed.

### 4. Verbose

Press **System Msg** to light the **Verbose** menu. At this point, you can press this softkey to view the complete information of the current row selected in the message list.

## License

DSG3000B provides various options to fulfill your measurement requirements. To order the corresponding option, please contact **RIGOL**.

Press **System** → **License** to enter the option management interface. You can view the option status of the instrument and the license of the option installed as well as install an option.

### 1. Option Information

Press **Option Info** and the option status of this instrument will be displayed.



## 2. License Information

Press **License Info** and the license of the option installed will be displayed.

## 3. Install

Press **Install** and input the option license to activate the corresponding option.

### Acquire the license:

- 1) Order the corresponding option to acquire the option key.
- 2) Log in to the **RIGOL** official website ([www.rigol.com](http://www.rigol.com)), click **License Activation** to enter the "Registered product license code" interface.
- 3) In the software license registration interface, input the correct key, serial number (press **System** → **Information** → **System Info** to acquire the instrument serial number), and the verification code. Click **Generate** to obtain the download link of the option license file. If you need to use the option license file, please click the link to download the file to the root directory of the USB storage device.

### Tips:

You can also install an option by operating the RF signal generator remotely.

1. Build the communication between the RF signal generator and PC. You can use the USB, LAN or USB-GPIB interface (option). For the connecting methods, please refer to "**Remote Control**".
2. Send the `:SYSTem:LKEY <license key>` command (for example, `:SYSTem:LKEY QA7ZCZEH6AC54SFNKA853MS5CB3A`); the RF signal generator identifies the license received and matches it with the corresponding option. At this point, the corresponding option is installed and activated.

## Self-test

### 1. Screen Test

Press **Screen Test** to enter the screen test interface. The system provides five colors (including white, blue, green, red and black) to test whether the screen has a dot defect. Press any key to switch the screen color and exit the test.

### 2. Key Test

Press **Key Test** to enter the key test interface. Press the function keys on the front panel one by one and check whether the corresponding key is illuminated. If not, failure might occur to that key. Press **Esc** for three consecutive times to exit the test.

**NOTE:** If the keys on the front panel are transparent buttons, the corresponding backlight will light on when testing.

## Sanitation

Press **System** → **Sanitation** to clear all data set by users and restore them to factory settings. The operation includes:

- Formatting NAND FLASH;
- Restoring user data saved in the NVRAM and NorFlash to factory settings.
- Restoring HOST NAME, IP address and password in LXI to factory settings.

## Chapter 3 Remote Control

DSG3000B series RF signal generator can communicate with USB, LAN and GPIB interfaces. This chapter describes the basic information and methods of remote control.

The contents of this chapter are as follows:

- Remote Control Overview
- Control Via USB
- Control Via LAN

# Remote Control Overview

The DSG3000B supports to build communication with the PC via USB, LAN or USB-GPIB interface (option) to realize remote control. The DSG3000B utilizes a SCPI command set (Standard Commands for Programmable Instruments) for remote instrumentation control. There are two modes as follows.



## 1. User-defined programming

Users can program and control DSG3000B by using the SCPI (Standard Commands for Programmable Instruments) commands. For more information about the commands and programming, refer to the *DSG3000B Programming Guide*.

## 2. Use PC software

Users can use the common PC software (Ultra Sigma) provided by **RIGOL** to send SCPI commands to control DSG3000B remotely.

This chapter will give a detailed introduction of how to use Ultra Sigma to control DSG3000B remotely through various interfaces. Acquire the Ultra Sigma software and install it and its components according to the instructions. You can download the latest version of the software from [www.rigol.com](http://www.rigol.com).

**NOTE:** When the instrument is in remote mode,  is displayed in the user interface and all the front panel keys (except ) are locked. At this point, you can press  to exit the remote mode.

## Control Via USB

### 1. Connect the device

Connect the RF signal generator (USB Device) and PC (USB Host) using USB cable.

### 2. Install USB drive

This RF signal generator is a USBTMC device and the **New Hardware Wizard** will be displayed after the RF signal generator is correctly connected to the PC (the signal generator will be automatically configured to USB interface) and both of them are started. Please install the "USB Test and Measurement Device (IVI)" drive program according to the instructions.

### 3. Search for device resource

Start Ultra Sigma and the software will search for the RF signal generator resource currently connected to the PC automatically. You can also click

**USB-TMC**

to search for the resource manually.

### 4. View device resource

The instrument model and USB interface information will be displayed under the "RIGOL Online Resource" directory, as shown in the figure below.

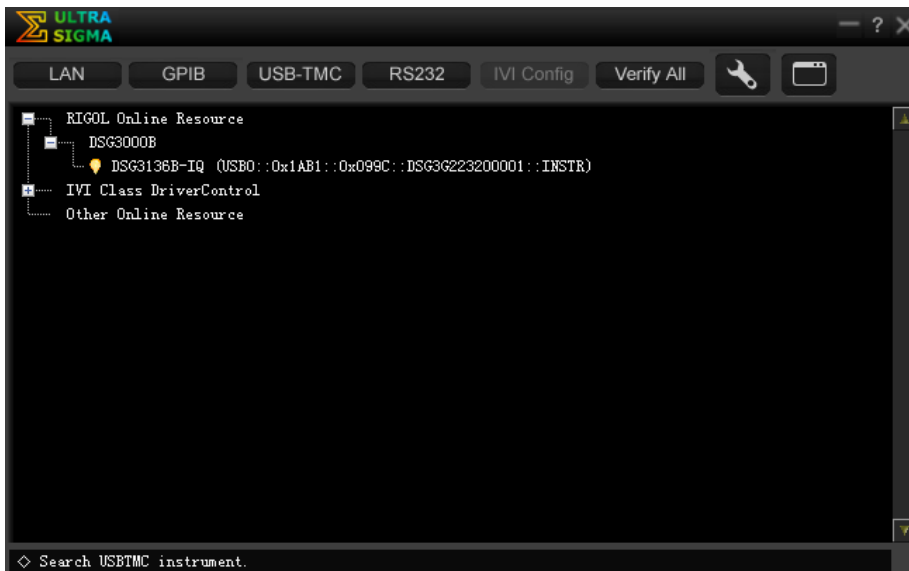

Figure 3-1 View USB Device Resource

### 5. Communication test

Right-click the resource name "DSG3136B-IQ (USB0::0x1AB1::0x099C::DSG3G223200001::INSTR)" and select "SCPI Panel Control" to open the remote command control panel through which you can

send commands and read data. For more information about the SCPI commands, refer to the *DSB3000B Programming Guide*.

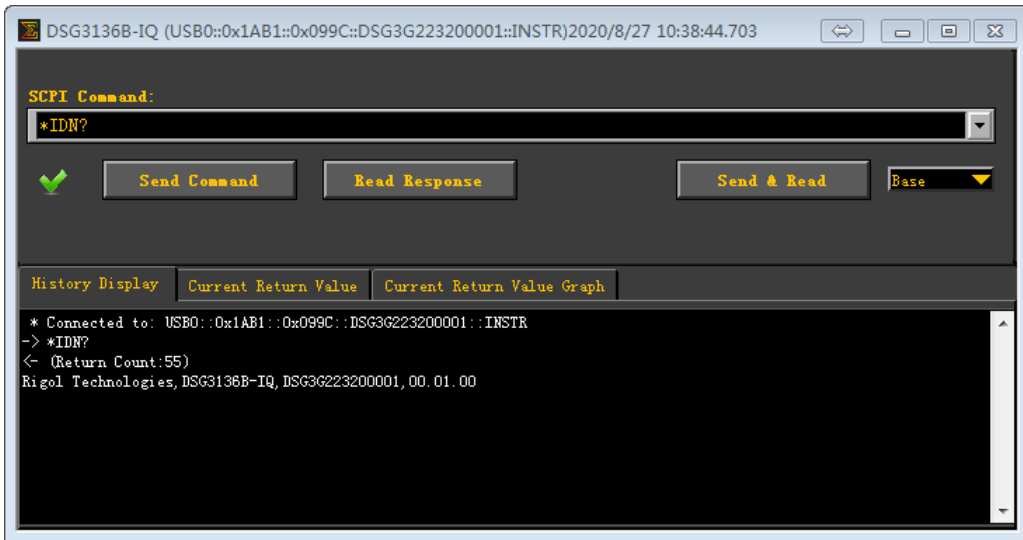

Figure 3-2 Read and Write Command via USB

## Control Via LAN

### 1. Connect the devices

Connect the RF signal generator to your LAN using network cable.

### 2. Configure LAN parameters

Set the LAN parameters of the RF signal generator according to the description in "I/O Config → LAN".

### 3. Search device resource

Start-up Ultra Sigma and click **LAN**, then click **Search** in the pop-up window, the software starts searching the RF signal generator resources connected to LAN. Instrument resources searched will be displayed in the right of the window. Select your desired resource and click **OK**, as shown in the following figures.

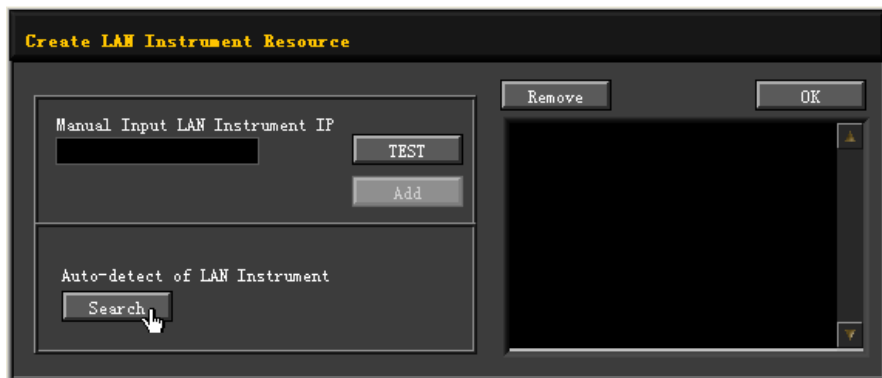

(a)



(b)

Figure 3-3 Search LAN resource

**NOTE:** The resource selected should keep consistency with IP address of the DSG3000B LAN interface.

#### 4. View the resource

The resources that have been searched successfully are shown in the "RIGOL Online Resource" catalog. See figure below.

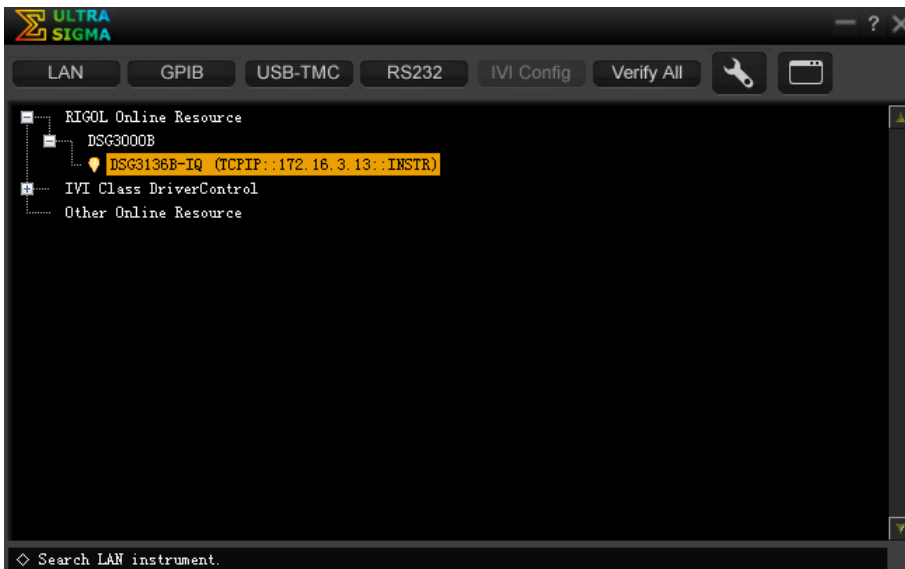

Figure 3-4 View the resource

#### 5. Communication test

Right-click the resource name "DSG3136B-IQ (TCPIP::172.16.3.13::INSTR)" and select "SCPI Panel Control" to open the interface below, from which you can write and read commands as shown in the figure below.

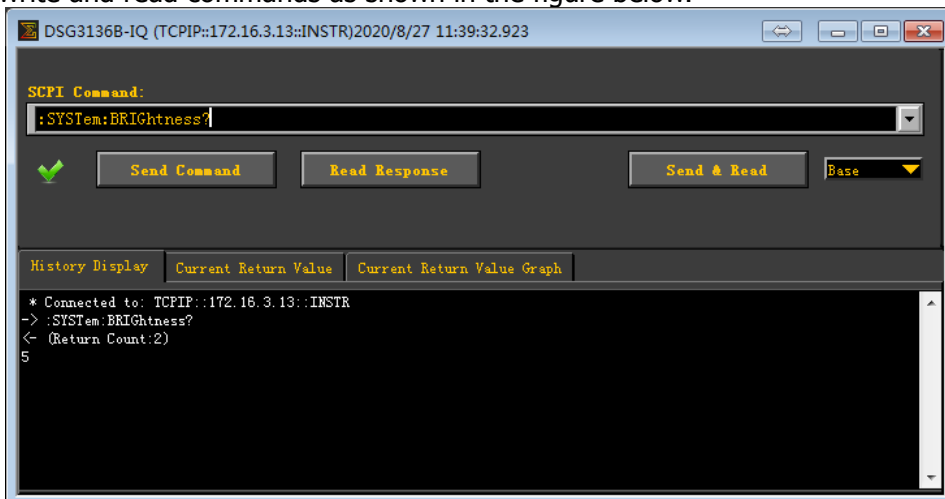

Figure 3-5 Write and read commands via LAN

#### 6. Load LXI webpage

The RF signal generator confirms to LXI Device Specification 2011 standard. You



can load LXI webpage conveniently by right-clicking the resource name and selecting "LXI-Web". From the webpage, you can see some important information about the instrument such as the model, manufacturer, serial number, description, MAC address and IP address, as shown in the figure below.

RIGOL Web-Enable DSG

Welcome Page

Network Status

Network Settings

Help

Security

LXI

Welcome to Web of DSG

Information About This Instrument:

Instrument Model:	DSG3136B-IQ
Manufacturer:	Rigol Technologies
Serial Number:	DSG3G223200001
Description:	
LXI Class:	LXI Core 2011
LXI Version:	1.4
Host Name:	
MAC Address:	9A-1B-FE-C8-59-D6
IP Address:	172.16.3.13
Firmware Revision:	00.01.00.00.08
VISA TCP/IP String:	TCP/IP0::172.16.3.13::INSTR
Auto-MDIX Capable:	NO
VISA USB Connect String:	USB0::0x1AB1::0x099C::DSG3G223200001::INSTR

Web Identification

Figure 3-6 LXI Webpage

**NOTE:** If you want to view or modify the current network setting of the instrument,

click  Network Settings and input the initial password "RIGOL" (must be uppercase letters) in the pop-up window (the user name is empty by default). Besides, you can

also click  Security to reset the password.



## Chapter 4 Application Examples

This chapter introduces the basic operations of the instrument as well as a few specific examples so that the user can quickly master the operation method of the RF signal generator.

The contents of this chapter are as follows:

- To Output RF Signal
- To Output RF Sweep Signal
- To Output RF Modulated Signal

## To Output RF Signal

Output a RF signal with 1 GHz frequency and -40 dBm amplitude from the **[RF OUTPUT 50Ω]** connector.

### 1. Restore to factory setting

Press **System** → **Reset** → **Preset Type** → "Factory" and then press **Preset** to restore the factory setting (by default, the frequency offset is 0 Hz and the amplitude offset is 0 dB).

### 2. Frequency setting

Press **FREQ** → **Frequency**, use the numeric keyboard to input the frequency value (1) and select the desired unit (GHz) from the pop-up unit menu or unit keys.

- The frequency units available are GHz, MHz, kHz and Hz.
- Pressing **Enter** to select the current frequency unit by default.
- You can also press the Left/Right arrow keys to enter the parameter editing state and move the cursor to the specified digit and then use the Up/Down arrow keys or the knob to modify the value.
- After the frequency is set, you can use the Up/Down arrow keys or the knob to modify the frequency at the current step value.
- Press **FREQ** → **Frequency** and then press **Step** to set the step value.

### 3. Amplitude setting

Press **LEVEL** → **Level**, use the numeric keyboard to input the amplitude value (-40) and select the desired unit (dBm) from the pop-up unit menu or unit keys. You can also press **Enter** to select the default unit dBm.

- The amplitude units available are dBm, -dBm, mV, uV and nV.
- You can also press the Left/Right arrow keys to enter the parameter editing state and move the cursor to the specified digit and then use the Up/Down arrow keys or the knob to modify the value.
- You can also use the Up/Down arrow keys or the knob to modify the amplitude at the current step value.
- Press **LEVEL** → **Level** and then press **Step** to set the step value.

### 4. Enable the RF output

Press **RF**, the backlight lights on and the RF label is displayed in the status bar of the user interface. The RF output is enabled. At this point, the **[RF OUTPUT 50Ω]** connector outputs RF signal according to the current configuration.



Figure 4-1 Parameter Setting Interface of RF Signal Output

## To Output RF Sweep Signal

This section introduces how to output a RF sweep signal by configuring continuous linear step sweep. Set the frequency range: 1 GHz to 2 GHz; the amplitude range: -20 dBm to 0 dBm. Set the number of sweep points to 10 and the dwell time to 500 ms.

### 1. Restore to factory setting

Press **System** → **Reset** → **Preset Type** → "Factory" and then press **Preset** to restore the factory setting (by default, the sweep mode is continuous, the sweep type is step and the sweep space is linear).

### 2. Step sweep parameter setting

Press **SWEEP** and use the menu page Up/Down key  to turn to the 2/3 menu page; then, press **Step Swp** to enter the step sweep parameter setting interface.

- Start Frequency  
Press **Start Freq**, use the numeric keyboard to input the start frequency value (1) and select the desired unit (GHz) from the pop-up unit menu or unit keys.
- Stop Frequency  
Press **Stop Freq**, use the numeric keyboard to input the stop frequency value (2) and select the desired unit (GHz) from the pop-up unit menu or unit keys.
- Start Level  
Press **Start Lev**, use the numeric keyboard to input the start level value (-20) and select the desired unit (dBm) from the pop-up unit menu or unit keys. You can also press **Enter** to select the default unit (dBm).
- Stop Level  
Press **Stop Lev**, use the numeric keyboard to input the stop level value (0) and select the desired unit (dBm) from the pop-up unit menu or unit keys. You can also press **Enter** to select the default unit (dBm).
- Sweep Points  
Press **Points**, use the numeric keyboard to input the number of sweep points (10) and then press **OK** or **Enter**.
- Dwell Time  
The dwell time indicates the duration of a sweep step.  
Press **Dwell Time**, use the numeric keyboard to input the time value (500) and select the desired unit (ms) from the pop-up unit menu or unit keys.

### 3. Enable the RF sweep

Press **[SWEEP]** → **Sweep** and select "Freq & Level" to enable the frequency and amplitude sweep functions at the same time.

At this point, the RF signal generator sweeps from the start frequency and level to the stop frequency and level continuously at certain step according to the current settings. The frequency and amplitude sweep progress bars as well as the continuous sweep label are displayed in the frequency and amplitude areas in the user interface respectively.

### 4. Enable the RF output

Press **[RF]**, the backlight lights on and the RF label is displayed in the status bar of the user interface. The RF output is enabled. At this point, the **[RF OUTPUT 50Ω]** connector outputs RF sweep signal according to the current configuration.

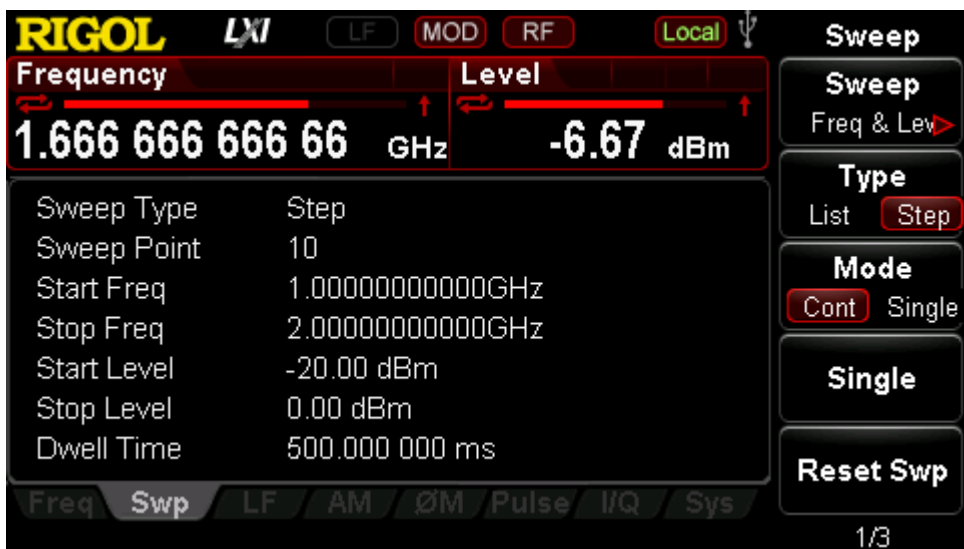

Figure 4-2 Parameter Setting Interface of RF Sweep Signal Output

## To Output RF Modulated Signal

This section introduces how to output an AM modulated signal. Set the carrier frequency to 800 MHz, the carrier amplitude to -20 dBm, the AM modulation depth to 60% and the modulation frequency to 20 kHz.

### 1. Restore to factory setting

Press **System** → **Reset** → **Preset Type** → "Factory" and then press **Preset** to restore the factory setting (by default, the modulation source is internal and the modulation waveform is sine).

### 2. Set the carrier frequency and amplitude

#### (1) Carrier Frequency

Press **FREQ** → **Frequency**, use the numeric keyboard to input the frequency value (800) and select the desired unit (MHz) from the pop-up unit menu or unit keys.

#### (2) Carrier Amplitude

Press **LEVEL** → **Level**, use the numeric keyboard to input the amplitude value (-20) and select the desired unit (dBm) from the pop-up unit menu or unit keys. You can also press **Enter** to select the default unit (dBm).

### 3. Set the AM modulation parameters

(1) Press **AM** to enter the amplitude modulation parameter setting interface.

(2) Press **Depth**, use the numeric keyboard to input the value of the modulation depth (60) and select the desired unit (%) from the pop-up unit menu or by pressing **Enter**.

(3) Press **Freq**, use the numeric keyboard to input the frequency value (20) and select the desired unit (kHz) from the pop-up unit menu or unit keys.

(4) Press **Switch** and select "On" to enable the AM function. The backlight of **AM** lights on.

### 4. Enable the RF modulation output

Press **MOD** and the backlight lights on. Then, press **RF** and the backlight lights on. The MOD and RF labels are displayed in the status bar of the user interface. The RF modulation output is enabled. At this point, the **[RF OUTPUT 50Ω]** connector outputs RF modulated signal according to the current configuration.

**NOTE:** The backlights of **RF** and **MOD** should light on.





Figure 4-3 Parameter Setting Interface of RF Modulated Signal Output



# Chapter 5 Troubleshooting

The chapter lists the commonly encountered failures and their solutions. When you encounter those problems, please solve them following the corresponding steps. If the problem remains still, please contact **RIGOL** and provide your device information (**System** → **Information** → **System Info**).

## 1. The screen of the RF signal generator is still dark (no display) after pressing the power key.

- (1) Check whether the fan is running;
  - If the fan is running but the screen is dark, the screen connecting wire might be loose.
  - If the fan is not running and the instrument does not start successfully, please go to step (2).
- (2) Check whether the power is correctly connected and the power switch is really on.
- (3) Check whether the fuse is burned out. If the fuse needs to be replaced, please use the specified fuse (AC 250 V, T3.15 A).
- (4) Restart the instrument after finishing the above inspections.
- (5) If it still does not work correctly, please contact **RIGOL**.

## 2. The screen is too dark and cannot be seen clearly.

- (1) Check whether the brightness setting of the LCD screen is too low.
- (2) Press **System** → **Display** → **Brightness** and use the numeric keys or up/down arrow keys to adjust the brightness of the LCD screen of the RF signal generator to a proper value.

## 3. The RF signal generator is locked.

- (1) Check whether the RF signal generator is in remote control mode (in remote control, **Rmt** is displayed in the status bar of the user interface). Pressing **Esc** can exit the remote control mode and unlock the front panel.
- (2) Check whether the RF signal generator is in local mode with the screen being locked (when the screen is locked, front panel operations are not available). Pressing **Esc** can unlock the screen and exit the locking state.
- (3) If progress bar is displayed on the screen of the signal generator, some operation is in progress. For example, when saving a file, the progress bar will be displayed indicating that the save operation is in progress. At this point, the front panel is locked.
- (4) Pressing **Preset** or restarting the signal generator can also unlock the instrument.

#### 4. The setting is correct but the waveform output is incorrect.

- (1) There is no RF output.
  - Check whether the signal connecting cable is tightly connected to the corresponding **[RF OUTPUT 50Ω]** connector.
  - Check whether the connecting cable has internal damage.
  - Check whether the connecting cable is tightly connected to the test instrument.
  - Check whether the backlight of **[RF]** lights on. If not, press this key to illuminate the backlight. At this point, the RF label is displayed in the status bar of the user interface and the RF output is enabled.
  - Check whether the output amplitude of the RF signal is too small. Adjust the output amplitude properly.
- (2) The RF output is not modulated.
  - Check whether the signal connecting cable is tightly connected to the corresponding **[RF OUTPUT 50Ω]** connector.
  - Check whether the connecting cable has internal damage.
  - Check whether the connecting cable is tightly connected to the test instrument.
  - Check whether the backlights of **[MOD]** and **[RF]** are both illuminated and check whether the modulation **Switch** is set to "On".
  - Check whether the modulation parameter setting is correct and adjust the parameter appropriately.
  - If external modulation source is used, make sure that the external source is correctly connected and outputs signal. At the same time, the external source should work within the specified range of the signal generator.

#### 5. The sweep is abnormal.

- (1) The sweep stagnates.

The sweep progress bar is displayed in the frequency area/amplitude area in the user interface indicating that the sweep is in progress. If the sweep stagnates, please check the following points.

  - At least one manner of sweep is enabled. Press **[SWEEP]** → **Sweep** to select "Freq", "Level" or "Freq & Level".
  - If single sweep mode is selected, press **Single** and the instrument performs a sweep if the trigger condition is met.
  - If the sweep trigger mode is not set to auto, press **[SWEEP]** → **Trig** → "Auto" to make sure whether the sweep stagnates due to the loss of sweep trigger.
  - If the point trigger mode is not set to auto, press **[SWEEP]** → **Point Trig** → "Auto" to make sure whether the sweep stagnates due to the loss of point trigger.
  - Make sure whether the dwell time is too large or too small that the sweep cannot be seen.
  - Make sure that at least two points are set in the step sweep or list sweep.

- (2) The dwell time of list sweep is incorrect.
  - Press **SWEEP** → **List Swp** to enter the sweep list interface.
  - Make sure whether the dwell time of the list sweep is correct.
  - If the dwell time is incorrect, re-edit it. If it is correct, turn to the next step.
  - Press **SWEEP** → **Sweep Type** to make sure that "List" sweep is selected.  
If "Step" sweep is currently selected, the signal generator sweeps according to the dwell time of the step sweep.
- (3) The list sweep information recalled from the register is lost.
  - The list sweep information cannot be stored in the status register of the instrument as a part of the instrument state.
  - The signal generator can only use the currently loaded list for sweep.
- (4) In list or step sweep, the amplitude does not change.
  - Make sure that the sweep manner is set to "Level" or "Freq&Level".
  - If the sweep manner is currently set to "Freq", the amplitude will not change.

## 6. The USB storage device cannot be recognized.

- (1) Check whether the USB storage device can work normally when connected to other instruments or PCs.
- (2) Make sure that the USB storage device used is a Flash type. This instrument does not support hardware USB storage device.
- (3) Restart the instrument and insert the USB storage again to check whether it can work normally.
- (4) If the USB storage device still cannot be used normally, please contact **RIGOL**.

## 7. No response or incorrect response when key is pressed.

- (1) After starting the instrument, make sure that whether all the keys are irresponsive.
- (2) Press **System** → **Self-test** → **Key Test** to enter the keyboard test interface. Press the function keys on the front panel sequentially and check whether some key gives no response or incorrect response when it is pressed.
- (3) If the above failures occur, the keyboard connecting wire might be loose or the keyboard is damaged. Please do not disassemble the instrument and contact **RIGOL**.

## 8. Performance specification test is not passed.

- (1) Check whether the RF signal generator is within calibration period (1 year).
- (2) Make sure that the RF signal generator is warmed up for at least 40 minutes before test.
- (3) Check whether the RF signal generator is under the specified temperature.
- (4) Check whether the test is being performed in a highly magnetic

environment.

- (5) Check whether the power supplies of RF signal generator and test system have strong interference.
- (6) Check whether the performance of the test device meets the requirement.
- (7) Make sure that the test device is within calibration period.
- (8) Check whether the test device meets the required conditions of the manual.
- (9) Check whether all connections are tight.
- (10) Check whether all cables have internal damage.
- (11) Make sure that the operations conform to settings and processes which are required by the performance verification manual.
- (12) Check whether the error calculation is a mistake.
- (13) The definitions of "Typical Value" and "Nominal Value" for this product should be correctly understood.
  - Typical Value: the performance specification of this product under specified conditions.
  - Nominal Value: the approximate quantity of the product during application.

## Chapter 6 Appendix

### Appendix A: DSG3000B Accessories and Options

	Description	Order Number
<b>Model</b>	Signal Generator, 9 kHz to 6.5 GHz	DSG3065B
	Signal Generator, 9 kHz to 6.5 GHz, I/Q Modulation (Std.)	DSG3065B-IQ
	Signal Generator, 9 kHz to 13.6 GHz	DSG3136B
	Signal Generator, 9 kHz to 13.6 GHz, I/Q Modulation (Std.)	DSG3136B-IQ
<b>Standard Accessories</b>	Power Cable	--
<b>Options</b>	Pulse Modulation, Pulse Generator, and Pulse Train Generator	DSG3000B-PUG
	High Stable OCXO Reference Clock	OCXO-B08
	Rack Mount Kit	RM-DSG3000
<b>Optional Accessories</b>	include: N(F)-N(F) adaptor (1pcs), N(M)-N(M) adaptor (1pcs), N(M)-SMA(F) adaptor (2pcs), N(M)-BNC(F) adaptor (2pcs), SMA(F)-SMA(F) adaptor (1pcs), SMA(M)-SMA(M) adaptor (1pcs), BNC T type adaptor (1pcs), 50 $\Omega$ SMA load (1pcs), 50 $\Omega$ BNC impedance adaptor (1pcs)	RF Adaptor Kit
	include: 50 $\Omega$ to 75 $\Omega$ adaptor (2pcs)	RF CATV Kit
	include: 6dB attenuator (1pcs), 10dB attenuator (2pcs)	RF Attenuator Kit
	N(M)-N(M) RF cable	CB-NM-NM-75-L-1 2G
	N(M)-SMA(M) RF cable	CB-NM-SMAM-75-L -12G
	USB-GPIB interface converter	USB-GPIB

**NOTE: All instruments, accessories and options can be ordered from your local RIGOL distributors.**

## Appendix B: Warranty

**RIGOL** TECHNOLOGIES CO., LTD. (hereinafter referred to as **RIGOL**) warrants that the product will be free from defects in materials and workmanship within the warranty period. If a product proves defective within the warranty period, **RIGOL** guarantees free replacement or repair for the defective product.

To get repair service, please contact with your nearest **RIGOL** sales or service office.

There is no other warranty, expressed or implied, except such as is expressly set forth herein or other applicable warranty card. There is no implied warranty of merchantability or fitness for a particular purpose. Under no circumstances shall **RIGOL** be liable for any consequential, indirect, ensuing, or special damages for any breach of warranty in any case.



# Index

Amplitude .....	2-4	LF Waveform .....	2-36
Amplitude Modulation.....	2-15	Limit .....	2-4
Amplitude Offset.....	2-5	List Sweep.....	2-8
Amplitude Sweep.....	2-7	Modulation Depth.....	2-16
Arm ARB.....	2-34	Modulation Frequency.....	2-16
Arm Auto .....	2-33	modulation source.....	2-30
Arm Retrigger.....	2-33	Modulation Waveform .....	2-16
Auto Trigger .....	2-12, 2-13, 2-32	OCXO.....	1-15
baseband output.....	2-31	operation mode.....	2-33
Bus Trigger .....	2-12, 2-13, 2-27, 2-33	Phase Deviation .....	2-22
clock frequency .....	2-32	Phase Modulation .....	2-21
Continuous Sweep .....	2-11	Phase Offset .....	2-3
DNS .....	2-48	Point Trigger Mode.....	2-12
Duration .....	2-34	Pulse Mode.....	2-25
Dwell Time.....	2-10	Pulse Modulation .....	2-24
Ext Delay .....	2-34	Pulse Output.....	2-27
Ext Inhibit.....	2-34	Pulse Period.....	2-25
External Coupling.....	2-17, 2-20	Pulse Width .....	2-25
External Gate .....	2-27	Reset Sweep.....	2-11
External Trigger.....	2-12, 2-13, 2-26, 2-33	Retrigger .....	2-33
Flatness Calibration .....	2-6	Single.....	2-34
Frequency.....	2-2	Single Sweep .....	2-11
Frequency Deviation .....	2-19	Start Frequency.....	2-9
Frequency Modulation .....	2-18	Start Level.....	2-9
Frequency Offset .....	2-2	Step Sweep .....	2-8
Frequency Sweep .....	2-7	Stop Frequency.....	2-9
Gateway .....	2-48	Stop Level .....	2-9
I/Q modulation .....	2-30	Subnet Mask.....	2-48
Input Impedance .....	2-17, 2-20, 2-23	Sweep.....	2-7
IP Address .....	2-48	Sweep Points .....	2-9
Key Trigger.....	2-12, 2-13, 2-27, 2-32	Sweep Shape .....	2-10
LAN .....	2-47	Sweep Space .....	2-10
Level .....	2-31	Train List .....	2-28
LF Amplitude.....	2-36	Trigger Delay .....	2-28
LF Frequency.....	2-37	trigger mode.....	2-32
LF Output .....	2-36	Trigger Mode .....	2-11, 2-26